

# G9409

## Mini Non-contact Tachometer User Manual

### I. Instruction

G9409 is a stable, safe and reliable non-contact tachometer. The core of the design is the microcontroller, photoelectric speed sampling processing, unique design makes it a superior performance tachometer.

#### △ Warning:

To avoid electric shock or injury, please read Safety Instructions and Warnings before operating this product.

### II. Open Box Inspection

Open the package box and take out the device. Please check whether the following items are deficient or damaged and contact your supplier immediately if they are.



1. Battery 1.5V AAA----- 3 pcs
2. Reflective strips----- 6pcs
3. User manual----- 1pcs

### III. Safety Instruction

In this manual, a Warning identifies conditions and actions that pose hazard(s) to the user or the test device.

- 1) Before use, inspect the tachometer for any damage. Pay particular attention to the insulation cover and the display screen. Do not use the meter if it is not working properly
- 2) Follow the operation instructions.
- 3) Do not point the laser directly into eyes.
- 4) Do not change the internal circuit.
- 5) When low power symbol  appears, replace the battery as soon as possible. Remove the battery if the meter is left unused for long time.
- 6) Do not store or use the meter in high temperature, high humidity, explosive, or strong magnetic field environments.
- 7) Use soft cloth and detergent to clean the case, do not use abrasants or solvents.

### IV. Symbols

	Warning
	Low power
	Comply with European Union standards

### V. Structure (figure 1)

1. Laser emission and receiving terminal
2. Case
3. Panel
4. Display screen
5. Functional buttons

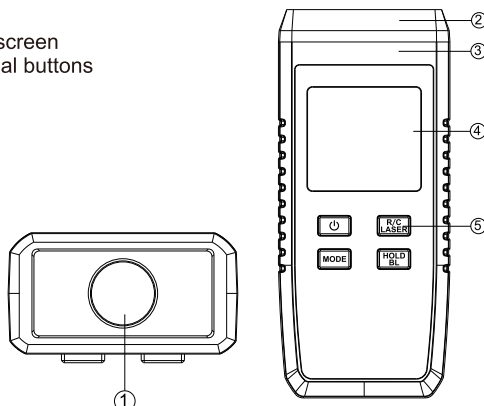

Figure 1

### VI. Indicators (figure 2)

1. Data hold
2. Laser ON
3. Maximum value
4. Minimum value
5. Low power
6. Signal receiving
7. Count measurement
8. Auto power off
9. RPM measurement

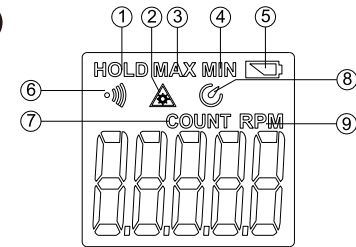









Figure 2

### VII. Buttons and setup

1. : Short press: Power ON/OFF, long press: switch ON/OFF auto power off function.  indicates auto power off.
2. : Short press: switch between RPM and COUNT modes. Long press: turn ON/OFF the laser.
3. : Under RPM mode: short press  to see past records (maximum or minimum value); long press  to delete the records. If there is signal input after power ON, maximum and minimum value will be recalculated. Under COUNT mode: press MODE to reset the count to zero.
4. : Short press to turn ON/OFF data hold function. Long press to turn ON/OFF backlight.

### VIII. Operation instructions

1. RPM measurement (see figure 3)

#### △ Warning:

To avoid injury and damage, keep the distance between tachometer and the object over 50mm.

- 1) Stop the rotating device
- 2) Cut the reflective strip (10mm \* 10mm) and place on rotating device.
- 3) Fix the meter to a location 50~200mm from the rotating object.
- 4) Short press  to turn on the meter, point the laser to the reflective strip (vertical angle  $\leq 30^\circ$ )
- 5) Turn on the rotating device to measure.

#### △ Note:

When measuring RPM < 50, pulse period may be long. Keep the meter still to ensure accuracy. Wait for the above two pulse signals to be accurate. The reading does not change if pulse period longer than 7 seconds. If rotating speed > 99999 RPM, OL symbol appears to indicate overrange.

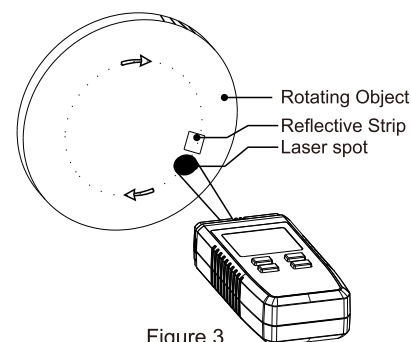



Figure 3

### 2. Count measurement

#### For illuminant objects

- 1) Fix the meter to a location 50~200mm from the rotating object. (vertical angle  $\leq 30^\circ$ )
- 2) Short press  to turn on the meter and short press  to select measurement mode. Point the laser to the objects to be measured.
- 3) After scanning the illuminant objects, the meter accumulates the count and displays the quantity.

Note: Object to be measured should be illuminant.

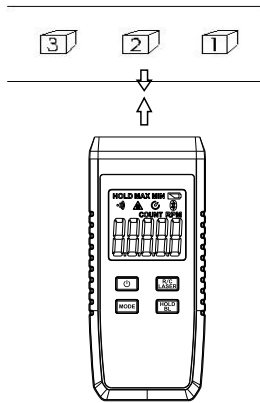

Figure 4

**For objects with external optical source.**

- 1) Fix the meter to a location 50~200mm from the rotating object. (vertical angle  $\leq 30^\circ$ )
- 2) Fix the optical source to the location at the other side of objects and opposite to the meter. (figure 5)
- 3) Short press  $\left[ \text{ON/OFF} \right]$  to turn on the meter, long press to turn off the laser.
- 4) When the objects pass by the meter and optical source the meter will accumulate the count and display quantity.

Note: If quantity >99999, OL symbol appears to indicate overrange. Press  $\left[ \text{MODE} \right]$  to reset the reading to 0.

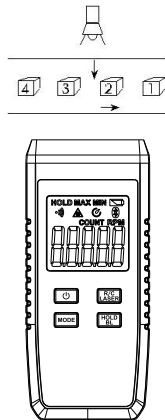

Figure 5

**IX. Technical specifications**

**1. General specifications**

- Maximum display: 99999
- Overage display: OL
- Low power:  $\left[ \text{Battery icon} \right]$
- Refresh rate: 1s~7s (according to rotating rate)
- Sensor type: photosensitive diode and laser tube
- Measuring distance: 50mm~200mm
- Drop test: 1m
- Battery: 1.5V(AAA)

**2. Operating environment**

- Indoor
- Altitude:  $\leq 2000$  meters
- Safety standards : EN61010-1; EN61010-031; EN61326
- Class of pollution: 2
- Operating temperature:  $0^\circ\text{C} \sim 50^\circ\text{C}$  ( $32 \sim 122^\circ\text{F}$ ) ( $\leq 80\% \text{RH}$ )
- Storage temperature:  $-20^\circ\text{C} \sim +60^\circ\text{C}$  ( $-4 \sim 140^\circ\text{F}$ ) ( $\leq 80\% \text{RH}$ )

**3. Electric specifications**

- Ambient temperature:  $23^\circ\text{C} \pm 5^\circ\text{C}$  ( $64.4 \sim 82.4^\circ\text{F}$ )
- Ambient humidity:  $\leq 80\% \text{RH}$

**(1) RPM**

Range	Resolution	Accuracy
10~9999.9r/min	0.1r/min	$\pm (0.04\% + 2)$
10000~99999r/min	1r/min	

**(2) COUNT**

Range	Resolution	Max input frequency
0~99999	1 digit	10KHz, 5% of pulse width

**Warning:**

To avoid false reading and injury, please do not open the case of the meter.

**X. Maintenance**

**1. General maintenance**

- a. The maintenance and service must be implemented by qualified professionals or designate departments.
- b. Clean the case with a dry cloth. Do not use abrasants or solvents.

**2. Battery installation & replacement.**

The meter uses three AAA 1.5V alkaline batteries for operation.

To install or replace the battery:

- a. Unscrew the battery cover, remove the cover and install new batteries ensuring that the correct polarity is observed.
- b. Use the batteries of the same type
- c. Replace the battery and screw up.

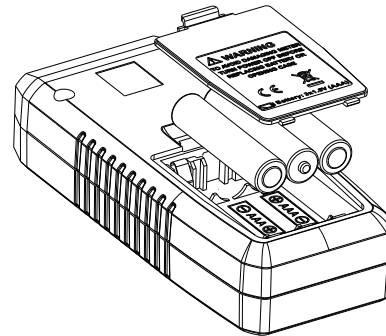

Figure 6