



## HAND TOOLS

## Diagonal Pliers



Tri-material comfort  
grip handle



CR-V Material

SKU	SKU Description
G80153	6" CR-V Diagonal Plier
G80154	7" CR-V Diagonal Plier

## End Cutting Plier



Tri-material comfort  
grip handle



CR-V Material

SKU	SKU Description
G80157	7" CR-V End Cutting Plier

## Linesman Pliers



Tri-material comfort grip handle



CR-V Material

SKU	SKU Description
G80155	6" CR-V Linesman Pliers
G80156	8" CR-V Linesman Pliers

## Long Nose Pliers



Tri-material comfort grip handle



CR-V Material

SKU	SKU Description
G80151	6" CR-V Long Nose Pliers
G80152	8" CR-V Long Nose Pliers

## Combination Pliers

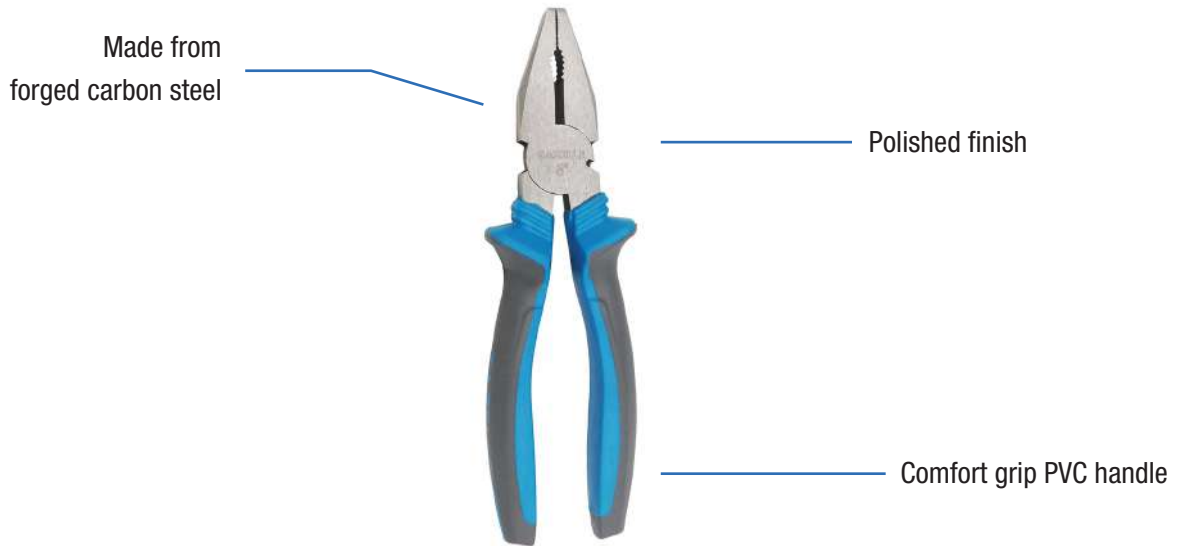

SKU	SKU Description
G80179	6" Combination Plier
G80180	8" Combination Plier

## Side Cutting Pliers

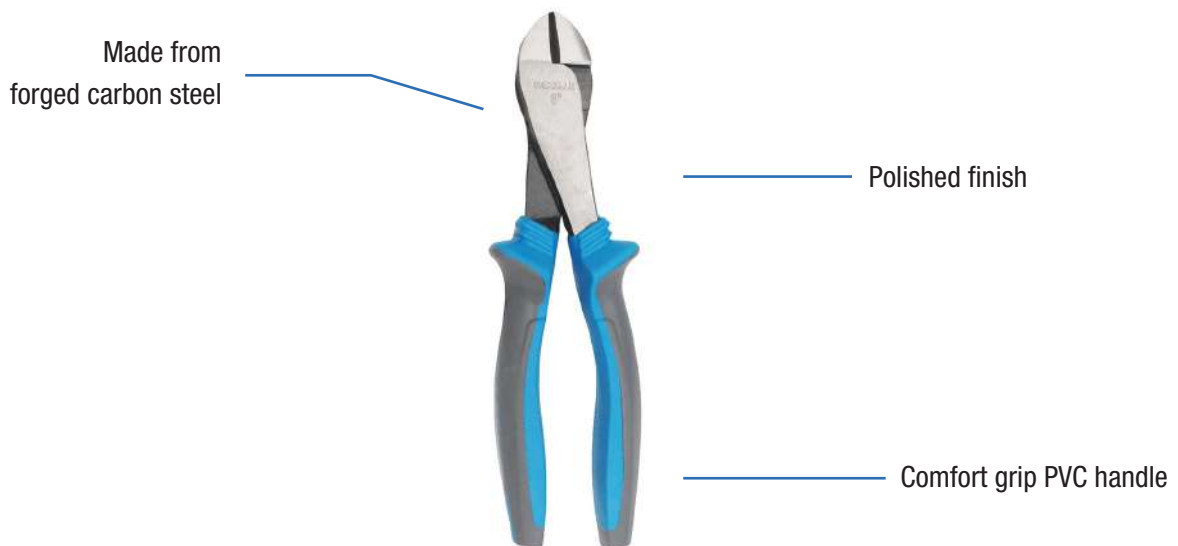

SKU	SKU Description
G80181	6" Side Cutting Plier
G80182	8" Side Cutting Plier

## Insulated Side Cutting Pliers

Made from  
forged carbon steel

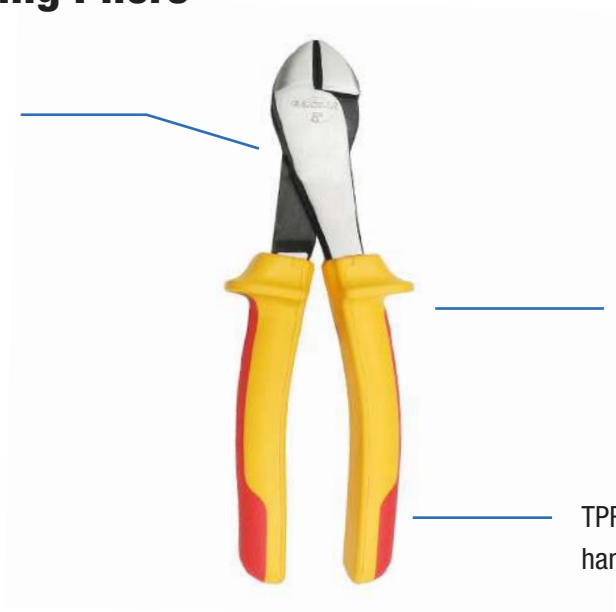

Insulated protection  
for voltage up to 1000V

TPR handle with guard prevents  
hand contact with conductive parts

SKU	SKU Description
G80187	6" Insulated Side Cutting Plier
G80188	8" Insulated Side Cutting Plier

## Insulated Long Nose Pliers

Made from  
forged carbon steel



Insulated protection  
for voltage up to 1000V

TPR handle with guard prevents  
hand contact with conductive parts

SKU	SKU Description
G80189	6" Insulated Long Nose Plier
G80190	8" Insulated Long Nose Plier

## Insulated Combination Pliers

Made from  
forged carbon steel



Insulated protection  
for voltage up to 1000V

TPR handle with guard prevents  
hand contact with conductive parts

SKU	SKU Description
G80185	6" Insulated Combination Plier
G80186	8" Insulated Combination Plier

## Insulated Wire Stripping Plier

Made from  
forged carbon steel



Insulated protection  
for voltage up to 1000V

TPR handle with guard prevents  
hand contact with conductive parts

SKU	SKU Description
G80191	6" Insulated Wire Stripping Plier

## Long Nose Pliers

Made from  
forged carbon steel



Polished finish

Comfort grip PVC handle

SKU	SKU Description
G80183	6" Long Nose Plier
G80184	8" Long Nose Plier

## Top Cutter

Made from  
forged carbon steel

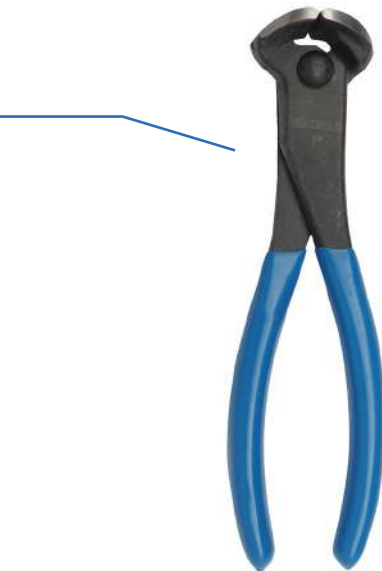

Black phosphate finish

SKU	SKU Description
G80194	7" Top Cutter

## Cable Cutter



SKU	SKU Description
G80362	8" Cable Cutter

## Aviation Tin Snips



SKU	SKU Description
G80120	10" Right Cut Aviation Tin Snip
G80121	10" Left Cut Aviation Tin Snip
G80123	10" Straight Cut Aviation Tin Snip

## Aviation Tin Snips



Serrated cutting edges prevent materials from slipping during use

Chrome molybdenum

Ergonomic comfort grip handle

SKU	SKU Description
G80120N	10" Right Cut Aviation Tin Snip
G80121N	10" Left Cut Aviation Tin Snip
G80123N	10" Straight Cut Aviation Tin Snip

## Tape Measures w/ Rubber Cover



SKU	SKU Description
G80106	3m (10ft) Tape Measure with Rubber Cover
G80171	5m (16ft) Tape Measure with Rubber Cover
G80172	8m (26ft) Tape Measure with Rubber Cover

## Chrome Tape Measure

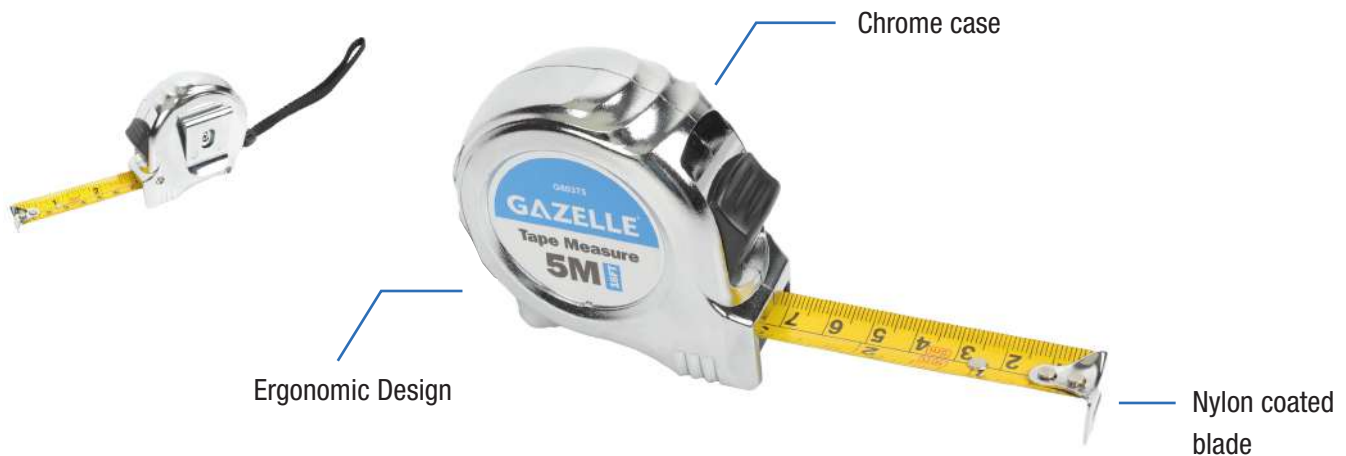

SKU	SKU Description
G80375	5m (16ft) × 19mm Chrome Tape Measure

## 6-pc. Screwdriver Set (Metric)



SKU	SKU Description
G80135	6-pc Screwdriver Set (Metric)

## 8-pc. Screwdriver Set (Metric)

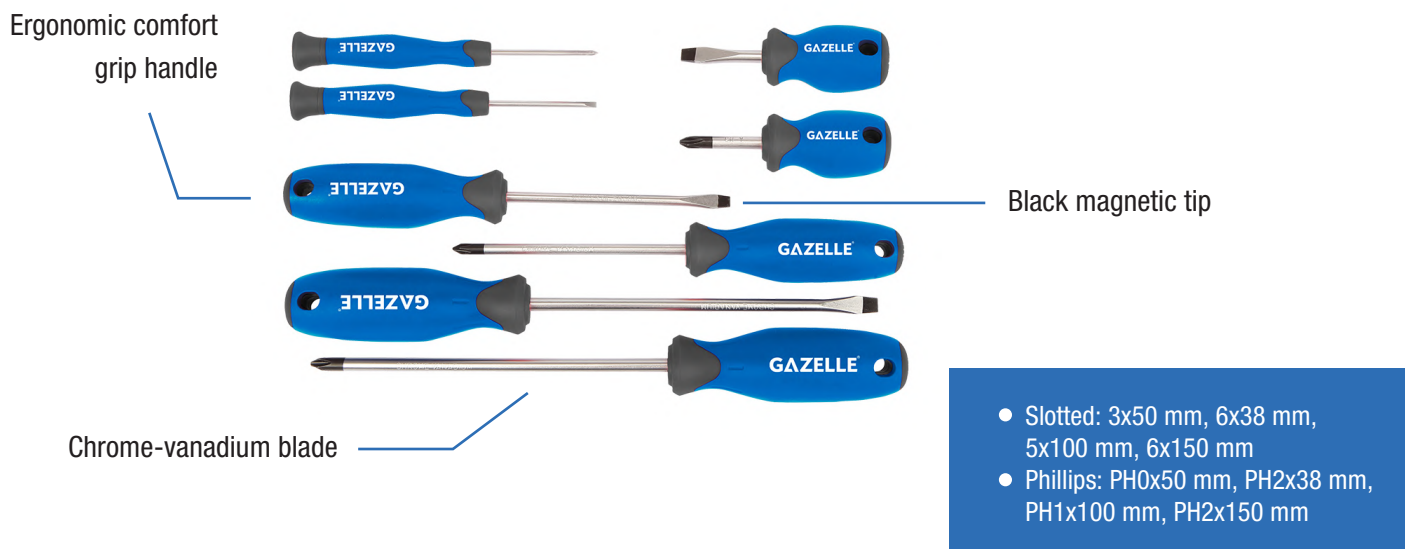

SKU	SKU Description
G80136	8-pc Screwdriver Set (Metric)

## Precision Screwdriver Set



SKU	SKU Description
G80137	6-pc. Precision Screwdriver Set (Metric)

## Dual-drive Ratchet Screwdriver Set



SKU	SKU Description
G80210	28-pc. Dual-drive Ratchet Screwdriver Set

## 6-piece Slotted Screwdriver Set



Ergonomic comfort-grip handle design



Chrome-vanadium steel,  
hardened and tempered

- 3x75mm Slotted Screwdriver
- 5x75mm Slotted Screwdriver
- 5x150mm Slotted Screwdriver
- 6x100mm Slotted Screwdriver
- 6x200mm Slotted Screwdriver
- 8x200mm Slotted Screwdriver

SKU

G80282

SKU Description

6-pc Slotted Screwdriver Set

## 6-piece Phillips Screwdriver Set



Ergonomic comfort-grip handle design



Chrome-vanadium steel,  
hardened and tempered

- PH0X75mm Phillipps Screwdriver
- #1x100mm Phillipps Screwdriver
- #1x150mm Phillipps Screwdriver
- #2x100mm Phillipps Screwdriver
- #2x200mm Phillipps Screwdriver
- #3x200mm Phillipps Screwdriver

SKU

G80283

SKU Description

6-pc Phillipps Screwdriver Set

## 5-piece Torx Screwdriver Set



Ergonomic comfort-grip handle design



Chrome-vanadium steel,  
hardened and tempered

- T10x100mm Torx Screwdriver
- T15x100mm Torx Screwdriver
- T20x100mm Torx Screwdriver
- T25x100mm Torx Screwdriver
- T30x100mm Torx Screwdriver

SKU	SKU Description
G80284	5-pc Torx Screwdriver Set

## 1/2" Torque Wrench



SKU	SKU Description
G80291	1/2" Torque Wrench 40-220 Nm

## 13-piece 1000V Insulated Screwdriver Set



SKU	SKU Description
G80363	13-pc. 1000V Insulated Screwdriver Set

## 6-piece 1000V Insulated Screwdriver Set

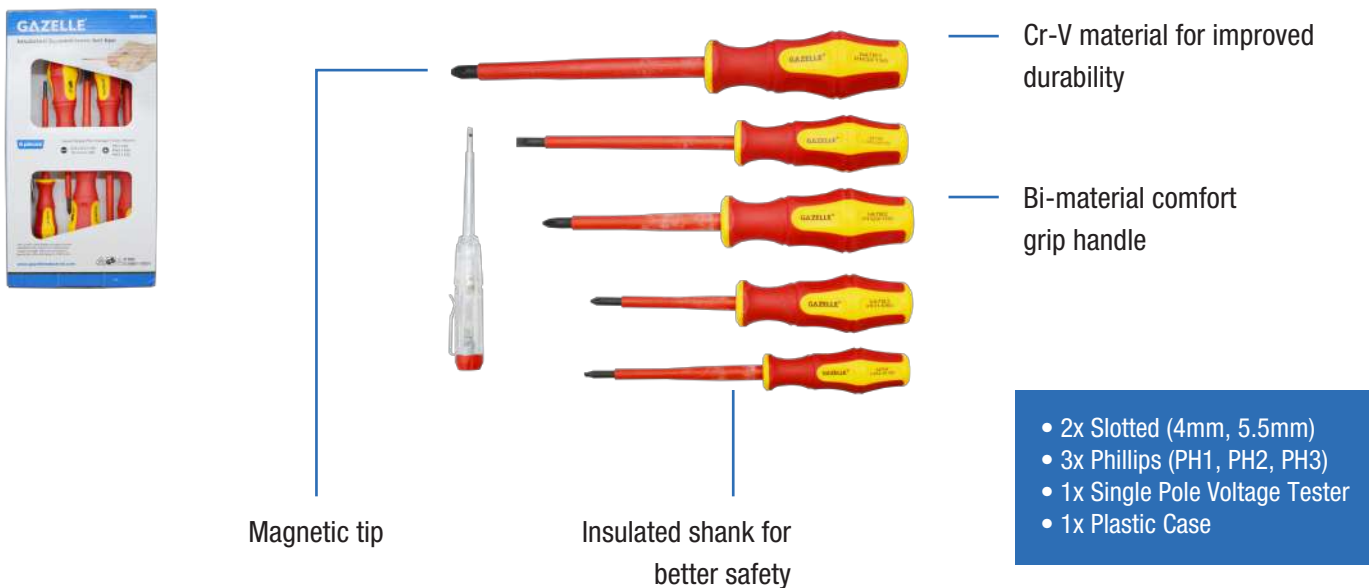

SKU	SKU Description
G80364	6-pc. 1000V Insulated Screwdriver Set

## 250V Voltage Tester



Cr-V material for improved durability

Insulated with high quality insulation resin



Tester light can be used continuously for 20,000 hours

Service life of 30,000 tests at 500V

**SKU**

**G80365**

**SKU Description**

100-250V Voltage Tester with Pen Holder

## Circlip Plier Set

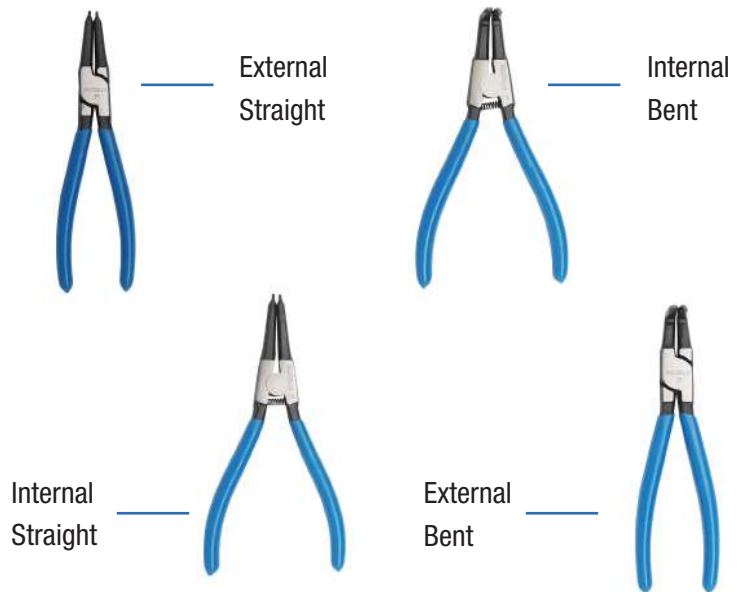
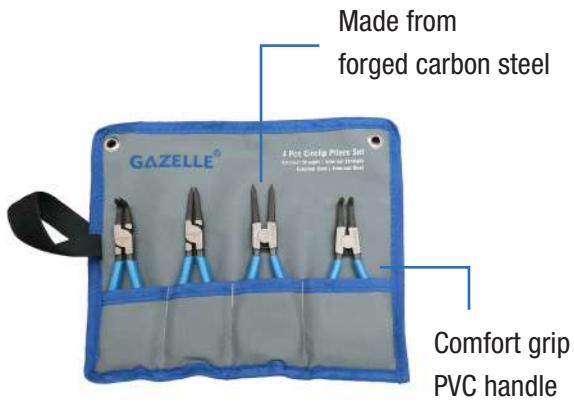

SKU	SKU Description
G80198	4 pc. 7" Circlip Plier Set

## MIG Welding Plier

Made from forged carbon steel



Polished finish

Comfort grip PVC handle

SKU	SKU Description
G80199	8" MIG Welding Plier

## Adjustable Wrenches

Made from  
Chromium Vanadium steel



Black phosphate finish

SKU	SKU Description
G80174	6" Adjustable Wrench
G80175	8" Adjustable Wrench
G80176	10" Adjustable Wrench
G80177	12" Adjustable Wrench
G80178	15" Adjustable Wrench

## Waterpump Pliers

Made from  
Chromium Vanadium steel



Black phosphate finish

Bi-material comfort grip handle

SKU	SKU Description
G80192	10" Waterpump Plier
G80193	12" Waterpump Plier

## Groove Joint Pliers



Tri-material comfort grip handle



CR-V Material

SKU	SKU Description
G80158	10" CR-V Groove Joint Pliers
G80159	12" CR-V Groove Joint Pliers

## Adjustable Wrenches



Dual-material comfort grip handle

Chrome vanadium steel construction for strength

Chrome plated for rust resistance and corrosion



Measurement markings

SKU	SKU Description
G80161	6" (160 mm) Adjustable Wrench
G80162	8" (200 mm) Adjustable Wrench
G80163	10" (250 mm) Adjustable Wrench
G80164	12" (300 mm) Adjustable Wrench

## Aluminum Pipe Wrenches

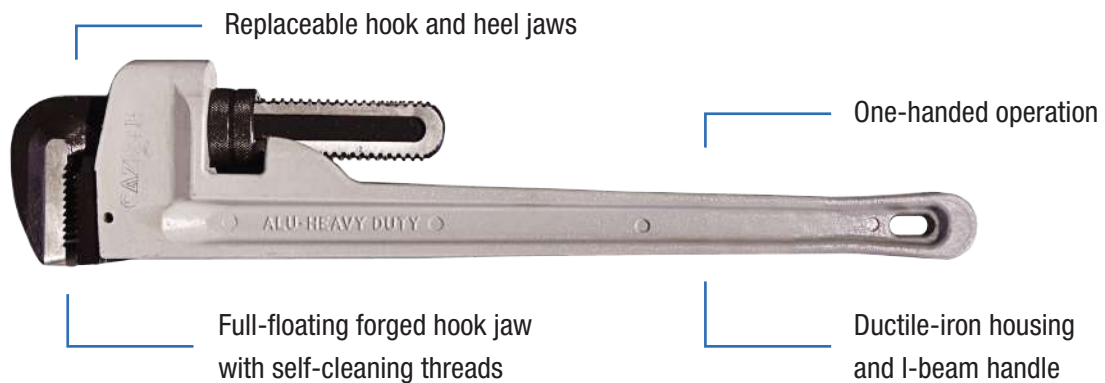

SKU	SKU Description
G80336	10" Aluminum Pipe Wrench
G80337	12" Aluminum Pipe Wrench
G80338	14" Aluminum Pipe Wrench
G80339	18" Aluminum Pipe Wrench
G80340	24" Aluminum Pipe Wrench
G80360	36" Aluminum Pipe Wrench
G80361	48" Aluminum Pipe Wrench

## Cast Iron Pipe Wrenches

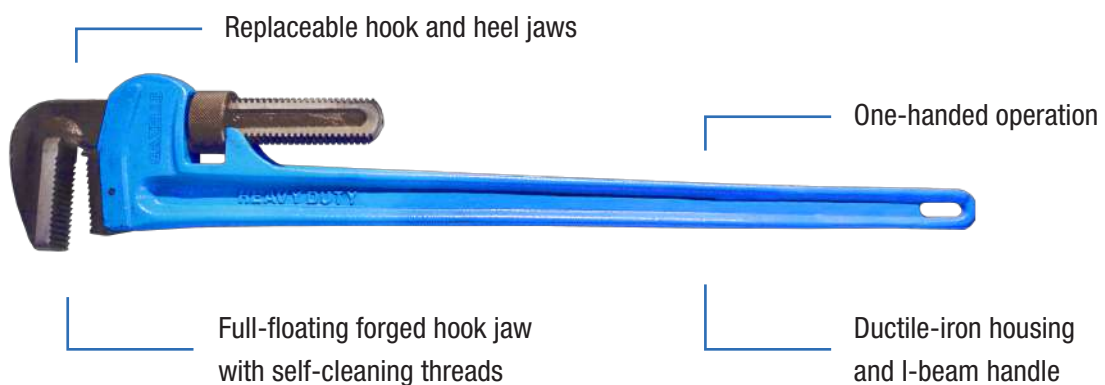

SKU	SKU Description
G80352	8" Cast Iron Pipe Wrench
G80353	10" Cast Iron Pipe Wrench
G80354	12" Cast Iron Pipe Wrench
G80355	14" Cast Iron Pipe Wrench
G80356	18" Cast Iron Pipe Wrench
G80357	24" Cast Iron Pipe Wrench
G80358	36" Cast Iron Pipe Wrench
G80359	48" Cast Iron Pipe Wrench

## Adjustable Basin Wrench

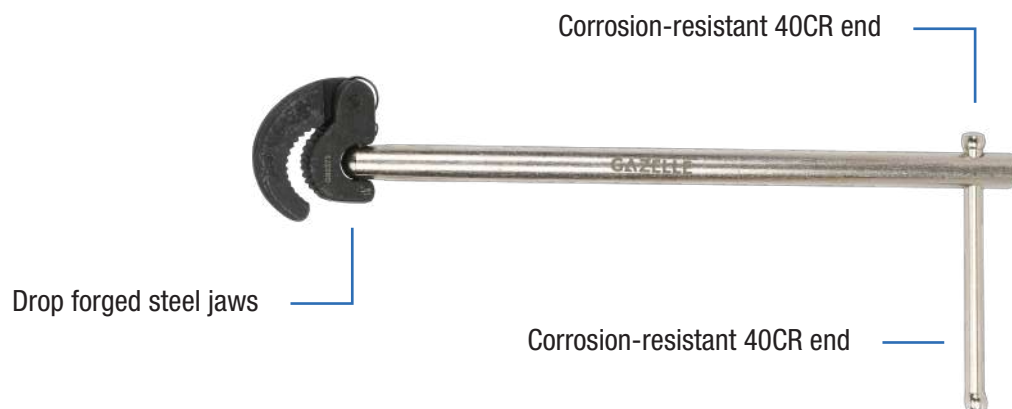

SKU	SKU Description
G80373	280mm (11") Adjustable Basin Wrench

## Combination Spanners

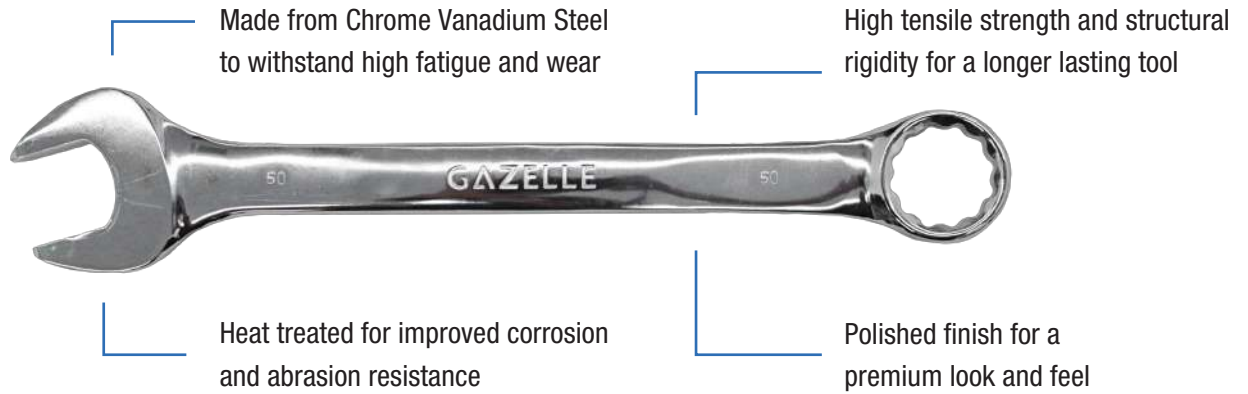

SKU	SKU Description
G80303	6mm Combination Spanner
G80304	7mm Combination Spanner
G80305	8mm Combination Spanner
G80306	10mm Combination Spanner
G80307	11mm Combination Spanner
G80308	12mm Combination Spanner
G80309	13mm Combination Spanner
G80310	14mm Combination Spanner
G80311	15mm Combination Spanner
G80312	16mm Combination Spanner
G80313	17mm Combination Spanner
G80314	18mm Combination Spanner
G80315	19mm Combination Spanner
G80316	21mm Combination Spanner
G80317	22mm Combination Spanner
G80318	23mm Combination Spanner
G80319	24mm Combination Spanner
G80320	25mm Combination Spanner
G80321	26mm Combination Spanner
G80322	27mm Combination Spanner
G80323	28mm Combination Spanner
G80324	30mm Combination Spanner
G80325	32mm Combination Spanner
G80329	34mm Combination Spanner
G80330	36mm Combination Spanner
G80331	38mm Combination Spanner
G80332	41mm Combination Spanner
G80333	46mm Combination Spanner
G80334	50mm Combination Spanner

## Combination Spanner Sets



**G80326**



**G80327**



Made from Chrome Vanadium Steel to withstand high fatigue and wear

High tensile strength and structural rigidity for a longer lasting tool

Heat treated for improved corrosion and abrasion resistance

**G80328**

Polished finish for a premium look and feel

### G80326 Combination Spanner Set

- 1x 8mm Spanner
- 1x 10mm Spanner
- 1x 11mm Spanner
- 1x 12mm Spanner
- 1x 13mm Spanner
- 1x 14mm Spanner
- 1x 17mm Spanner
- 1x 19mm Spanner
- 1x Trapezoidal plastic rack

### G80327 Combination Spanner Set

- 1x 8mm Spanner
- 1x 10mm Spanner
- 1x 12mm Spanner
- 1x 13mm Spanner
- 1x 14mm Spanner
- 1x 17mm Spanner
- 1x 19mm Spanner
- 1x 22mm Spanner
- 1x 24mm Spanner
- 1x 27mm Spanner
- 1x 30mm Spanner
- 1x 32mm Spanner
- 1x Double layer tetron pouch

### G80328 Combination Spanner Set

- 1x 1/4in Spanner
- 1x 5/16in Spanner
- 1x 3/8in Spanner
- 1x 7/16in Spanner
- 1x 1/2in Spanner
- 1x 9/16in Spanner
- 1x 5/8in Spanner
- 1x 11/16in Spanner
- 1x 3/4in Spanner
- 1x 13/16in Spanner
- 1x 7/8in Spanner
- 1x 1in Spanner
- 1x Double layer tetron pouch

SKU	SKU Description
<b>G80326</b>	8-pc. Combination Spanner Set (8-19mm)
<b>G80327</b>	12-pc. Combination Spanner Set (8-32mm)
<b>G80328</b>	12-pc. Combination Spanner Set (1/4-1in)

## Open End Spanner Sets



**G80299**

Made from Chrome Vanadium Steel to withstand high fatigue and wear

High tensile strength and structural rigidity for a longer lasting tool



Polished finish for a premium look and feel

Heat treated for improved corrosion and abrasion resistance

**G80300**

### G80299 Open End Spanner Set

- 1pc 6x7mm Spanner
- 1pc 8x9mm Spanner
- 1pc 10x11mm Spanner
- 1pc 12x13mm Spanner
- 1pc 14x15mm Spanner
- 1pc 16x17mm Spanner
- 1pc 18x19mm Spanner
- 1pc 20x22mm Spanner
- 1pc trapizoidal plastic rack

### G80300 Open End Spanner Set

- 1pc 6x7mm Spanner
- 1pc 8x9mm Spanner
- 1pc 10x11mm Spanner
- 1pc 12x13mm Spanner
- 1pc 14x15mm Spanner
- 1pc 16x17mm Spanner
- 1pc 18x19mm Spanner
- 1pc 20x22mm Spanner
- 1pc 21x23mm Spanner
- 1pc 24x27mm Spanner
- 1pc 25x28mm Spanner
- 1pc 30x32mm Spanner
- 1pc Double layer tetron pouch

SKU	SKU Description
<b>G80299</b>	8-pc. Open End Spanner Set (6-22mm)
<b>G80300</b>	12-pc. Open End Spanner Set (6-32mm)

## Ring Spanner Sets



**G80301**

Made from Chrome Vanadium Steel to withstand high fatigue and wear

High tensile strength and structural rigidity for a longer lasting tool



Polished finish for a premium look and feel

Heat treated for improved corrosion and abrasion resistance

**G80302**

### G80301 Ring Spanner Set

- 1pc 6x7mm Ring Spanner
- 1pc 8x9mm Ring Spanner
- 1pc 10x11mm Ring Spanner
- 1pc 12x13mm Ring Spanner
- 1pc 14x15mm Ring Spanner
- 1pc 16x17mm Ring Spanner
- 1pc 18x19mm Ring Spanner
- 1pc 20x22mm Ring Spanner
- 1pc trapizoidal plastic rack

### G80302 Ring Spanner Set

- 1pc 6x7mm Ring Spanner
- 1pc 8x9mm Ring Spanner
- 1pc 10x11mm Ring Spanner
- 1pc 12x13mm Ring Spanner
- 1pc 14x15mm Ring Spanner
- 1pc 16x17mm Ring Spanner
- 1pc 18x19mm Ring Spanner
- 1pc 20x22mm Ring Spanner
- 1pc 21x23mm Ring Spanner
- 1pc 24x27mm Ring Spanner
- 1pc 25x28mm Ring Spanner
- 1pc 30x32mm Ring Spanner
- 1pc Double layer tetron pouch

SKU	SKU Description
<b>G80301</b>	8-pc. Ring Spanner Set (6-22mm)
<b>G80302</b>	12-pc. Ring Spanner Set (6-32mm)

## Ratchet Spanner Set

Heat treated for improved corrosion and abrasion resistance

Polished finish for a premium look and feel

Made from Chrome Vanadium Steel to withstand high fatigue and wear

High tensile strength and structural rigidity for a longer lasting tool



SKU	SKU Description
G80335	7-pc. Ratchet Spanner Set (8-19mm)

### G803335 Ratchet Spanner Set

- 1x 8mm Spanner
- 1x 10mm Spanner
- 1x 11mm Spanner
- 1x 12mm Spanner
- 1x 13mm Spanner
- 1x 14mm Spanner
- 1x 17mm Spanner
- 1x 19mm Spanner
- 1x Trapizodal Plastic Rack

## Curved Jaw Locking Plier



Quick, easy locking and release action

Turn screw to adjust holding pressure and fit work

Chrome-vanadium steel jaw for maximum durability

Guarded release helps keep work fast and safe

SKU	SKU Description
G80285	250mm (10") Curved Jaw Locking Plier

## Long Nose Straight Jaw Locking Plier



Quick, easy locking and release action

Turn screw to adjust holding pressure and fit work

Chrome-vanadium steel jaw for maximum durability

Guarded release helps keep work fast and safe

SKU	SKU Description
G80286	230mm (9") Long Nose Straight Jaw Locking Plier

## C-Clamp Locking Plier

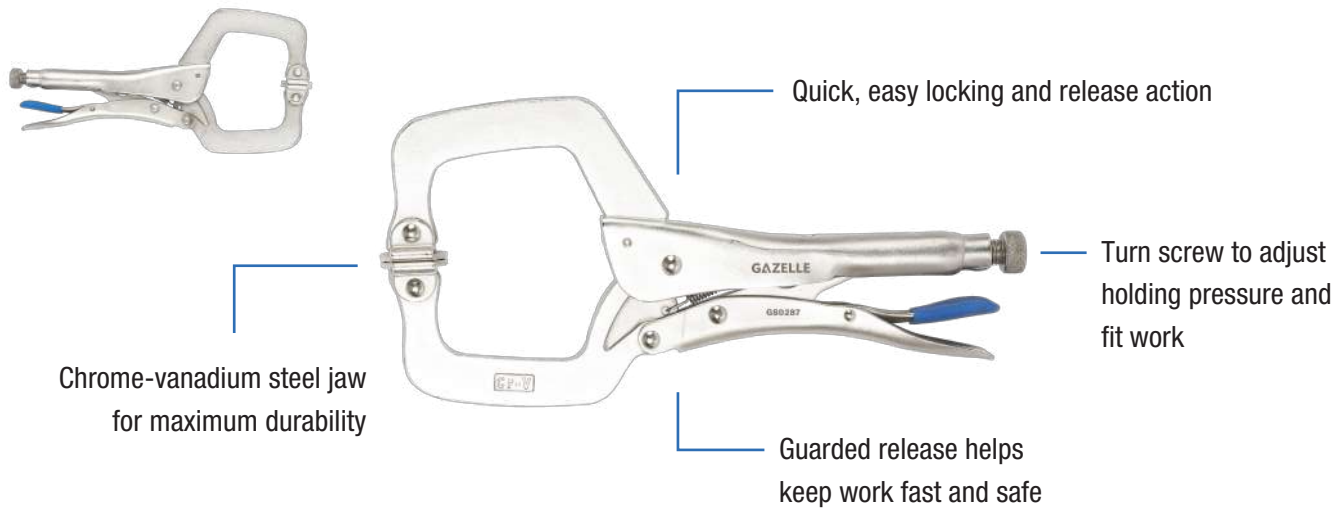

SKU	SKU Description
G80287	280mm (11") C-Clamp Locking Plier

## Bimetal HSS Hacksaw Blade

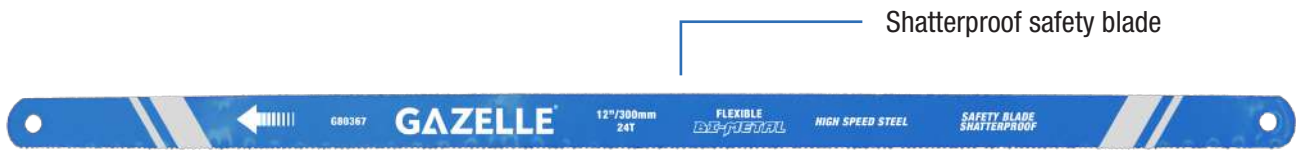

Flexible Bi-metal high speed steel construction

Longer lasting than regular carbon steel blade

Shatterproof safety blade

SKU	SKU Description
G80366	100-pc. Bimetal HSS Hacksaw Blade 12in, 18T
G80367	100-pc. Bimetal HSS Hacksaw Blade 12in, 24T

## Bimetal Cobalt Hacksaw Blade



Flexible Bi-metal cobalt construction

Longer lasting than HSS and carbon steel blades

Shatterproof safety blade

SKU	SKU Description
G80368	100-pc. Bimetal Cobalt Hacksaw Blade 12in, 18T

## Bimetal Cobalt Blade For Reciprocating Saw



Flexible Bi-metal cobalt construction

SKU	SKU Description
G80369	5-pc. Bimetal Cobalt Reciprocating Saw Blade 12in, 14T
G80384	5-pc. Bimetal Cobalt Reciprocating Saw Blade 9in, 6T
G80385	5-pc. Bimetal Cobalt Reciprocating Saw Blade 6in, 18T
G80386	5-pc. Bimetal Cobalt Reciprocating Saw Blade 8in, 10/14T

## Retractable Utility Knife

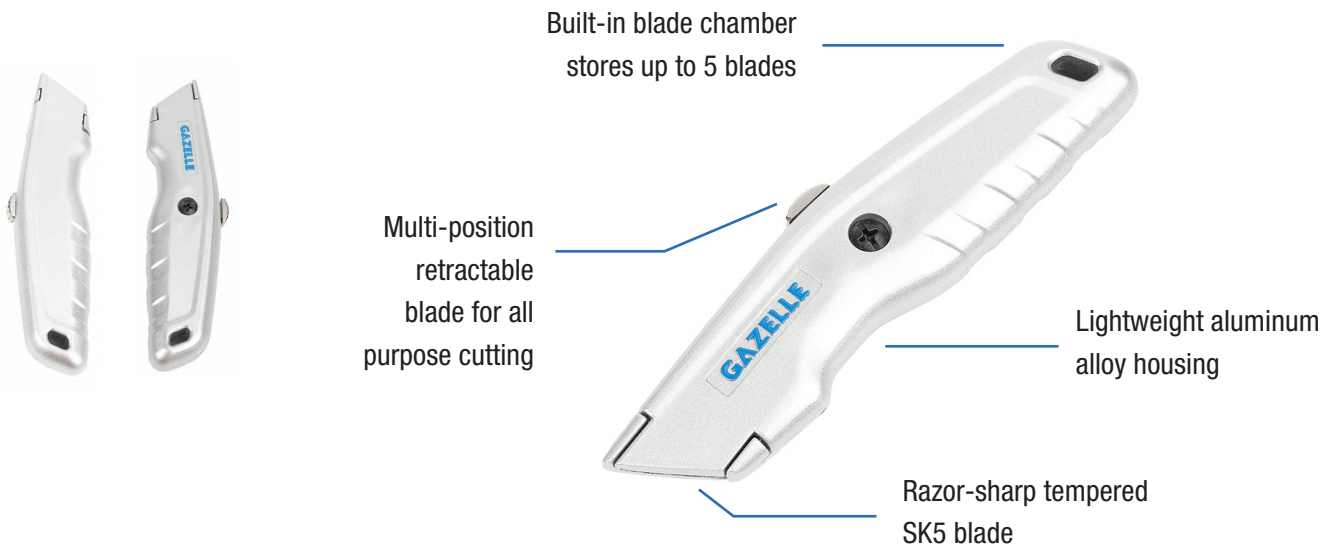

SKU	SKU Description
G80100	Retractable Utility Knife

## Auto-Retracting Safety Knife



SKU	SKU Description
G80102	Auto-Retracting Safety Knife

## Quick-Change Utility Knife



3 pcs. extra blades  
stored in handle



Die-cast aluminium body  
with comfort grip

SKU	SKU Description
G80103	Quick-Change Utility Knife

## Utility Knife Blades



Regular-duty utility blade for  
light sheet materials, paper  
and cardboard

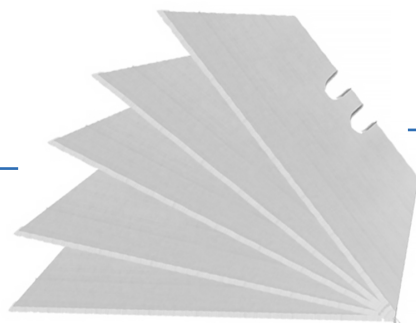

Fits most standard utility knives

SK5 blade

SKU	SKU Description
G80111	10-Pc. Utility Knife Blades
G80112	100-Pc. Utility Knife Blades

## Plastic Snap-off Knife

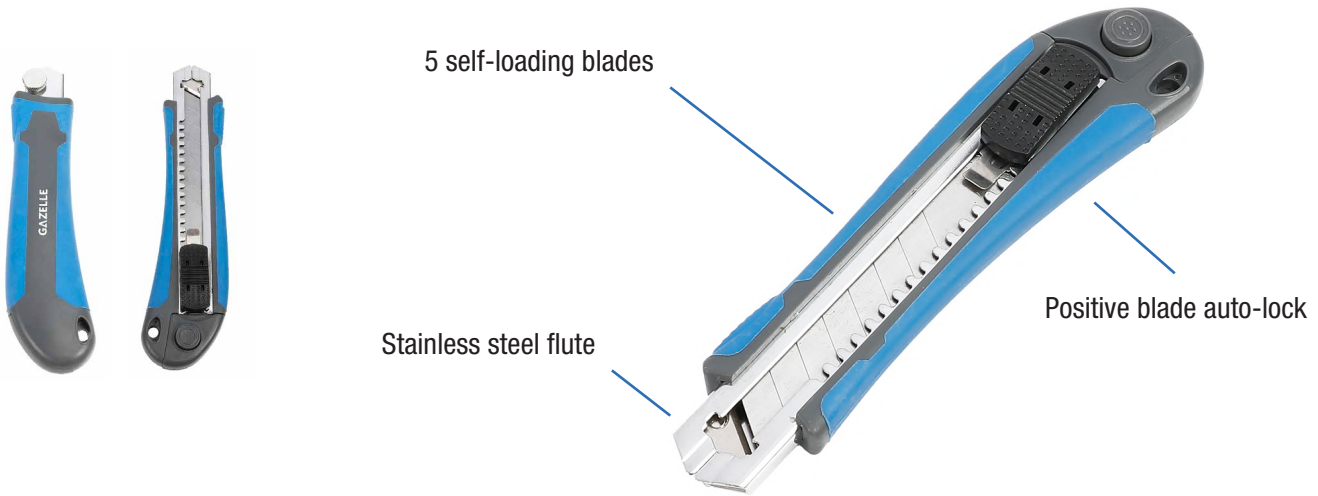

SKU	SKU Description
G80105	18 mm Plastic Snap-off Knife

## Snap Off Knife Blade

Fits most 9mm/18mm  
snap-off knives blade

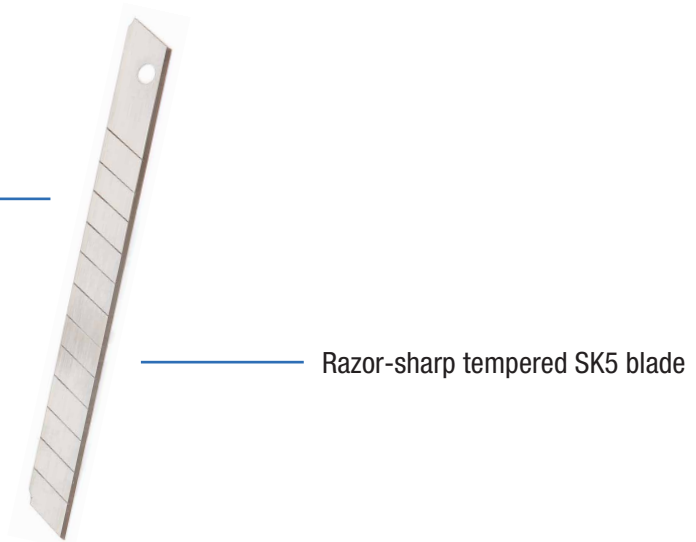

SKU	SKU Description
G80113	10pc/pack 18 mm Snap Off Knife Blade

## Retractable Folding Utility Knife w/ Blade Storage



SKU	SKU Description
G80104	Retractable Folding Utility Knife with Blade Storage

## 15-in-1 Aluminum Handle Multi Tool



SKU	SKU Description
G80200	15-in-1 Aluminum Handle Multi Tool

## Folding Hex Key Set



Ergonomic comfort-grip handle design



Chrome-vanadium steel, hardened and tempered

- Size: 1.5, 2, 2.5, 3, 4, 5, 6, 8 mm

SKU	SKU Description
G80130	8-pc. Folding Hex Key Set

## Folding Hex Key Set



Ergonomic comfort-grip handle design



Chrome-vanadium steel, hardened and tempered

- Hex Keys: 5/64, 3/32, 7/64, 1/8, 9/64, 5/32, 3/16, 7/32, 1/4

SKU	SKU Description
G80132	9-pc. Folding Hex Key Set

## Folding Torx Key Set



Ergonomic comfort-grip handle design

Chrome-vanadium steel, hardened and tempered

- Size: T9, T10, T15, T20, T25, T27, T30, T40

SKU	SKU Description
G80131	8-pc. Folding Torx Key Set

## Hand Riveter



One wrench stored in handle

Spring loaded handle ejects rivet stem automatically



Steel construction with ergonomic grip handle

Chrome molybdenum jaws

- Fits rivet size: 3/32", 1/8", 5/32" and 3/16"

SKU	SKU Description
G80138	10" Hand Riveter

## Long Arm Metric Hex Key Set



Ergonomic comfort-grip handle design

Chrome-vanadium steel, hardened and tempered

- Metric Hex Keys: 1.5, 2, 2.5, 3, 4, 5, 6, 8, 10 mm

SKU	SKU Description
G80133	9-pc. Long Arm Metric Hex Key Set

## Long Arm Imperial Hex Key Set



Ergonomic comfort-grip handle design

Chrome-vanadium steel, hardened and tempered

- Imperial Hex Keys: 1/16", 5/64", 3/32", 1/8", 5/32", 3/16", 1/4", 5/16", 3/8"

SKU	SKU Description
G80134	9-pc. Long Arm Imperial Hex Key Set

## Long Arm Ballpoint Hex Key Set



- 1x 1.5mm Hex key
- 1x 2.0mm Hex key
- 1x 2.5mm Hex key
- 1x 3.0mm Hex key
- 1x 4.0mm Hex key
- 1x 5.0mm Hex key
- 1x 6.0mm Hex key
- 1x 8.0mm Hex key
- 1x 10.0mm Hex key

**SKU**

**G80141**

**SKU Description**

9-pc. Long Arm Ballpoint Hex Key Set (1.5-10mm)

## Steel Carpenter Square

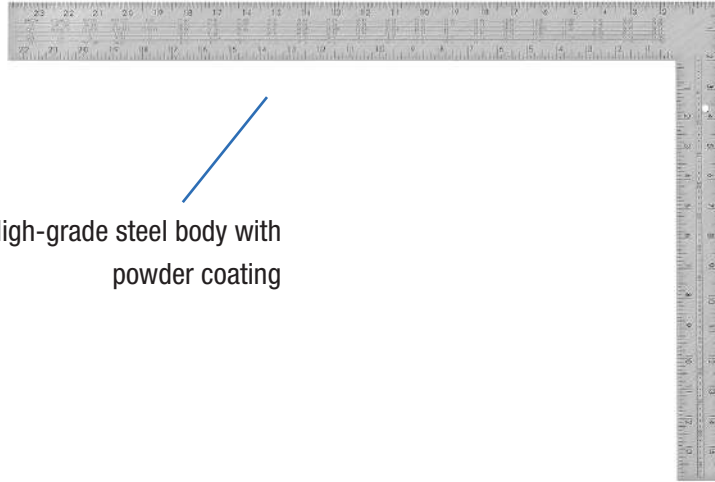

High-grade steel body with powder coating

SKU	SKU Description
G80173	400x600 mm Steel Carpenter Square

## Stainless Steel Rulers

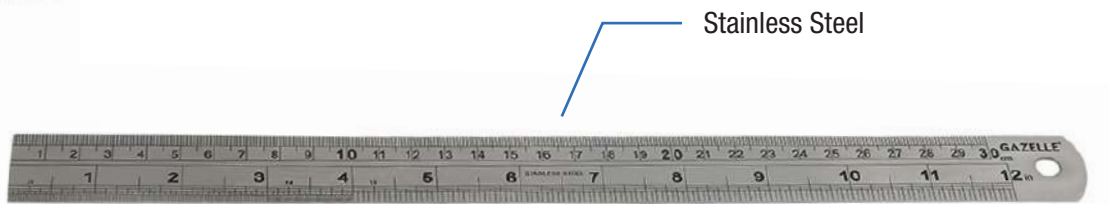

Stainless Steel

Permanently etched graduation

SKU	SKU Description
G80218	12" Stainless Steel Ruler
G80219	48" Stainless Steel Ruler

## Aluminum Combination Square w/ Aluminum Alloy Handle

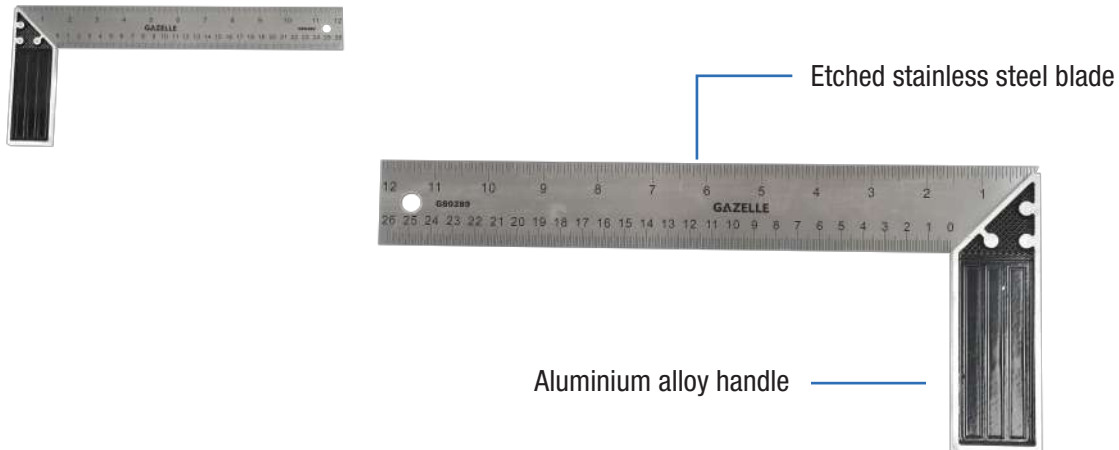

SKU	SKU Description
G80289	12" Aluminum Combination Square w/ Aluminum Alloy Handle

## Aluminum Combination Square

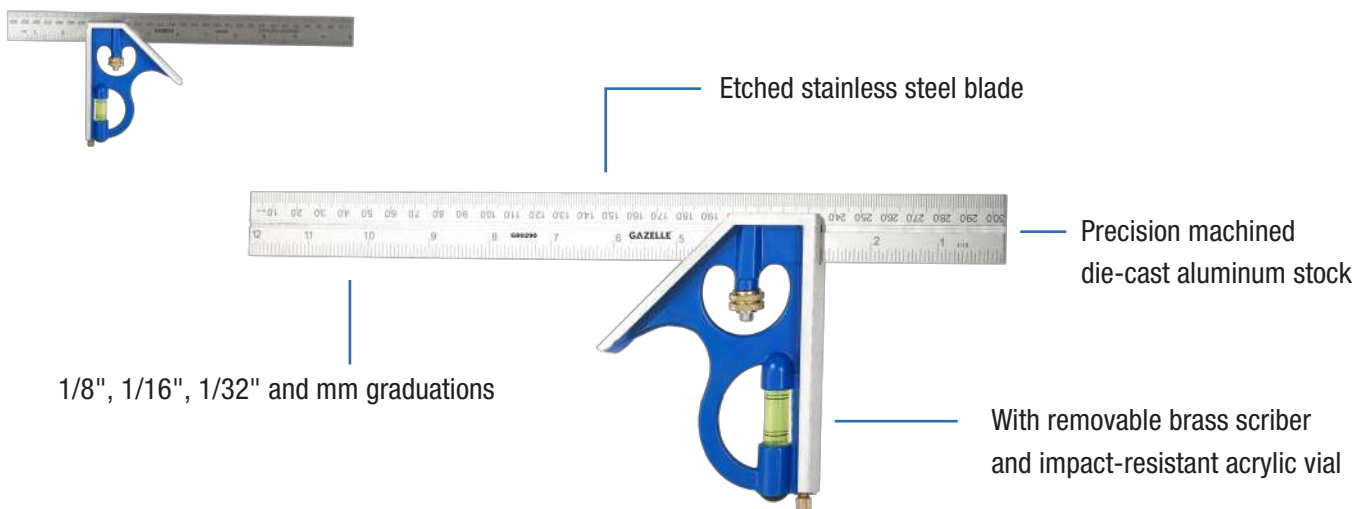

SKU	SKU Description
G80290	12" Aluminum Combination Square

## Caulking Gun

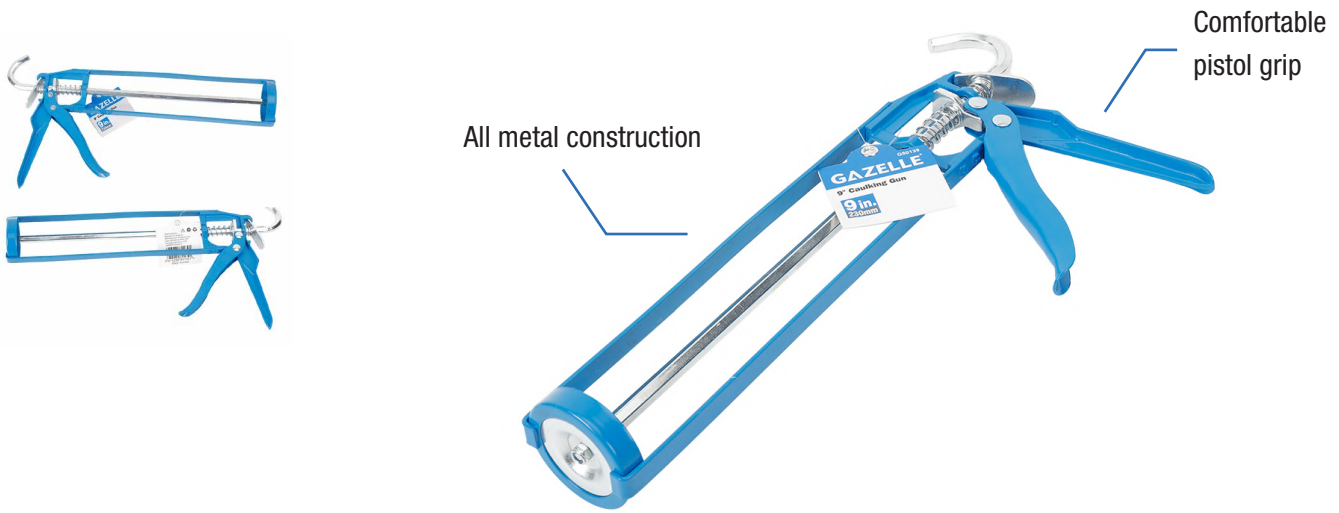

SKU	SKU Description
G80139	9" Caulking Gun

## Caulking Gun w/ Ratchet

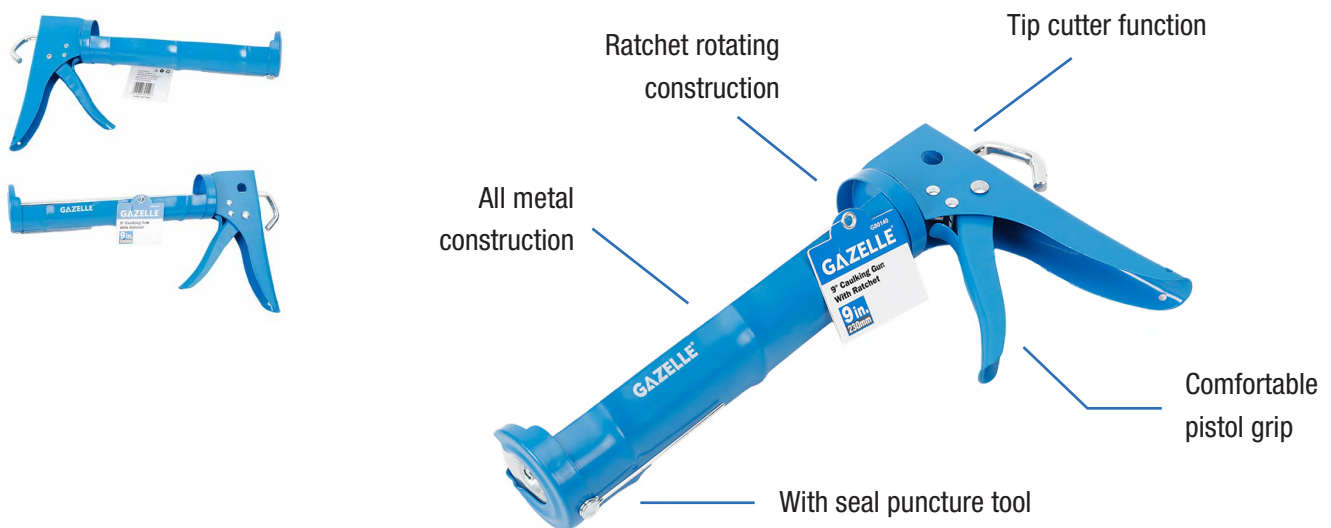

SKU	SKU Description
G80140	9" Caulking Gun with Ratchet

## Professional Hack Saw



SKU	SKU Description
G80125	12" (300mm) Professional Hack Saw

## Heavy Duty Hack Saw

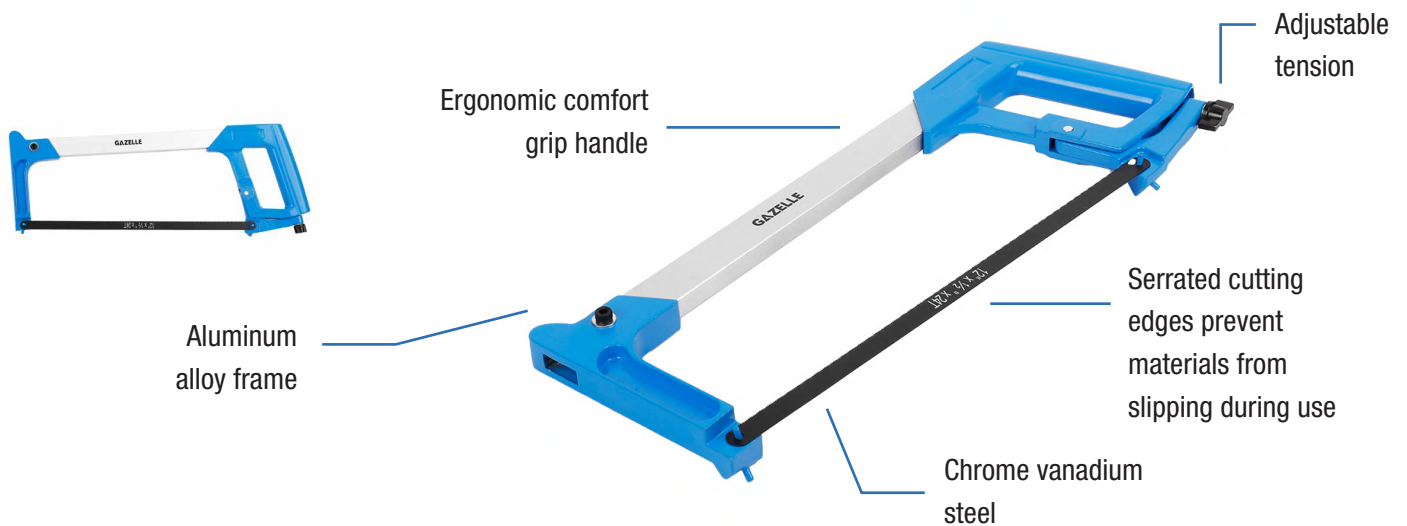

SKU	SKU Description
G80124	12" (300 mm) Heavy Duty Hacksaw

## Junior Hacksaw

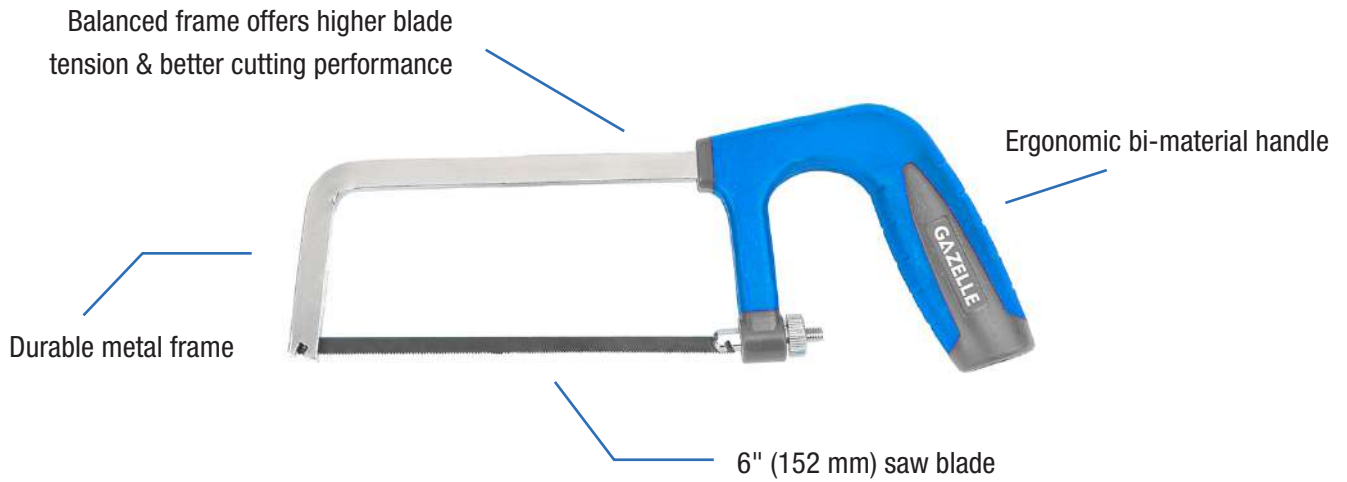

SKU	SKU Description
G80208	6" (150 mm) Junior Hack Saw

## Heavy Duty Hand Saws

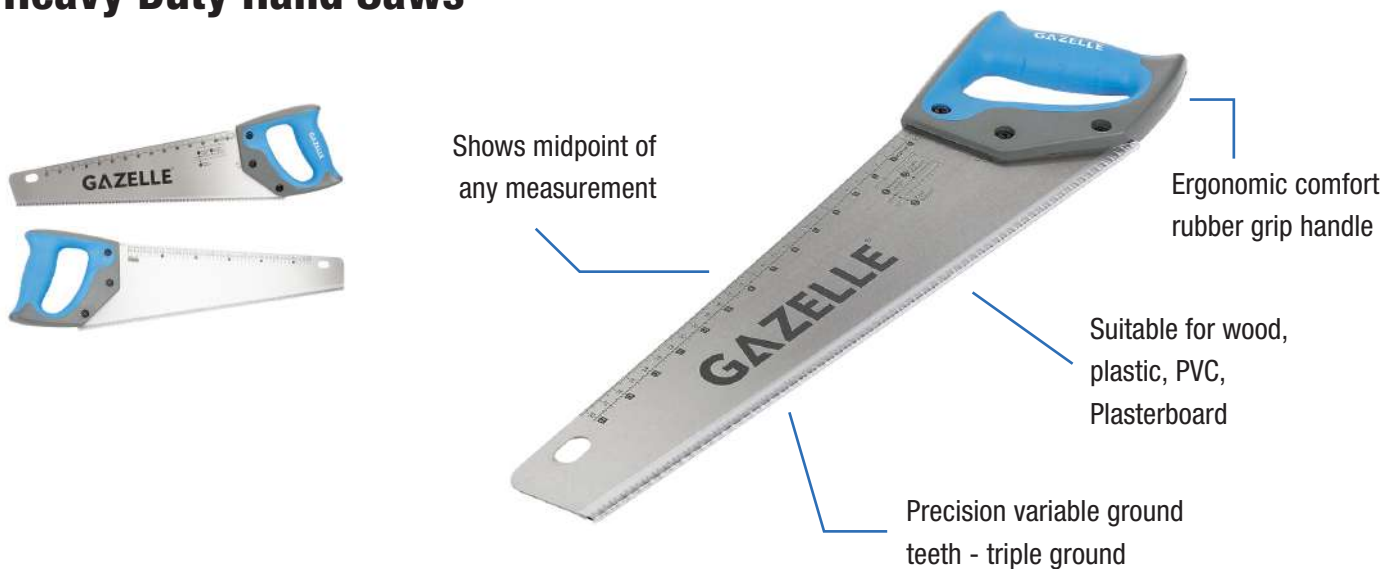

SKU	SKU Description
G80126	16" Hand Saw
G80127	18" Hand Saw
G80128	20" Hand Saw
G80129	22" Hand Saw

## Junior Saw Frame



SKU	SKU Description
G80253	6" Junior Saw Frame

## Junior Hacksaw Blades Set



SKU	SKU Description
G80254	6" Junior Hacksaw Blades Set

## Concrete Point Chisel



SKU	SKU Description
G80240	10" Concrete Point Chisel
G80241	12" Concrete Point Chisel

## Cold Flat Chisel



SKU	SKU Description
G80242	6" Cold Flat Chisel
G80243	8" Cold Flat Chisel
G80244	10" Cold Flat Chisel

## Cold Flat Chisel w/ Grip



SKU	SKU Description
G80245	10" Cold Flat Chisel w/ Grip
G80246	12" Cold Flat Chisel w/ Grip
G80247	18" Cold Flat Chisel w/ Grip

## Centre Punch Round Head

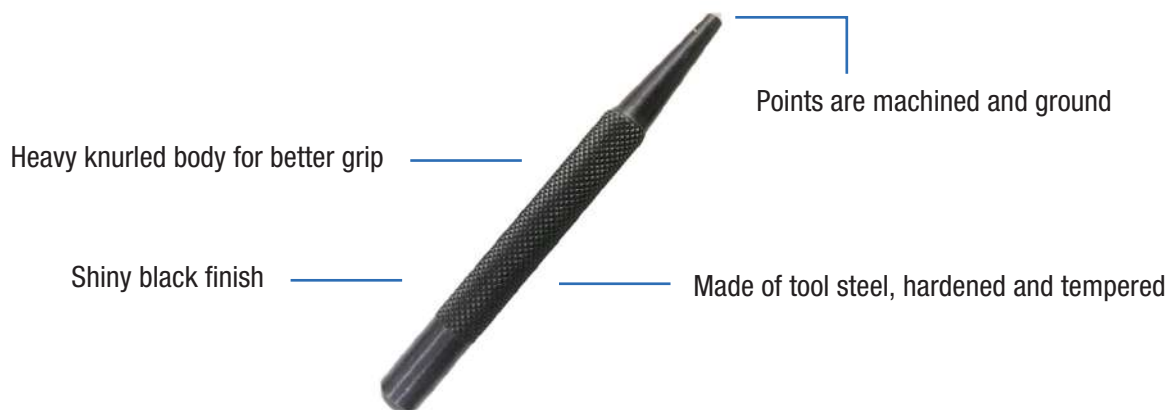

SKU	SKU Description
G80248	4x100 mm Centre Punch Round Head
G80249	6x125 mm Centre Punch Round Head

## 5-Piece File Set



Soft grip handle for user comfort



Small files for crafts and delicate application

- 8" Flat File
- 8" Half Round File
- 8" Round File
- 8" Triangular File
- 8" Square File

SKU	SKU Description
G80292	5-pc 8" File Set

## 10-Piece Diamond Needle File Set

Soft grip handle for user comfort



Small files for crafts and delicate application

SKU	SKU Description
G80293	10-pc Diamond Needle File Set

## Centre Punch Set



Heavy knurled body  
for better grip

Shiny black finish



Points are machined and ground

Made of tool steel,  
hardened and tempered

- Size: 1.6mm, 2.0mm, 2.4mm, 3.6mm, 4.0mm

**SKU**

**G80250**

**SKU Description**

5-pc. Centre Punch Set

## Pin Punch Set



Heavy knurled body  
for better grip

Shiny black finish



Made of tool steel,  
hardened and tempered

- Size: 3mm, 4mm, 5mm, 6mm, 7mm, 8mm

**SKU**

**G80252**

**SKU Description**

6-pc. Pin Punch Set

## Automatic Centre Punch



SKU	SKU Description
G80251	1/2" Automatic Centre Punch

## Letters Punch Sets



SKU	SKU Description
G80346	1/4" (6mm) Stamps Letter Set
G80347	5/16" (8mm) Stamps Letter Set
G80348	3/8" (10mm) Stamps Letter Set

## Numbers Punch Sets



SKU	SKU Description
G80349	1/4" (6mm) Stamps Number Set
G80350	5/16" (8mm) Stamps Number Set
G80351	3/8" (10mm) Stamps Number Set

## Wallboard Saw

Hardened and tempered 65Mn blade for strength and durability



Super-sharp cross ground teeth for fast cutting in drywall, wood or plastic

SKU	SKU Description
G80207	6" (150 mm) Wallboard Saw

## Steel Wire Brush

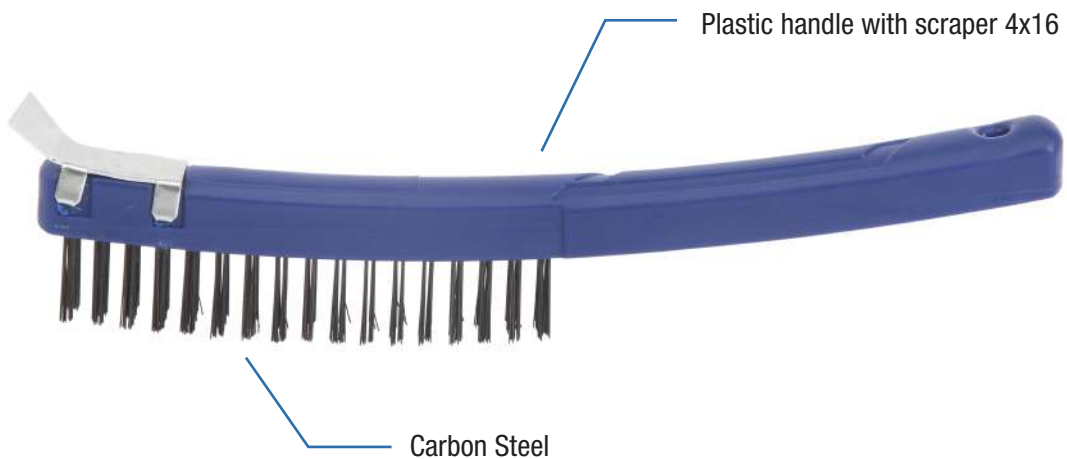

SKU	SKU Description
G80217	4x16 Steel Wire Brush

## Ball Pein Hammer w/ Fiberglass Handle

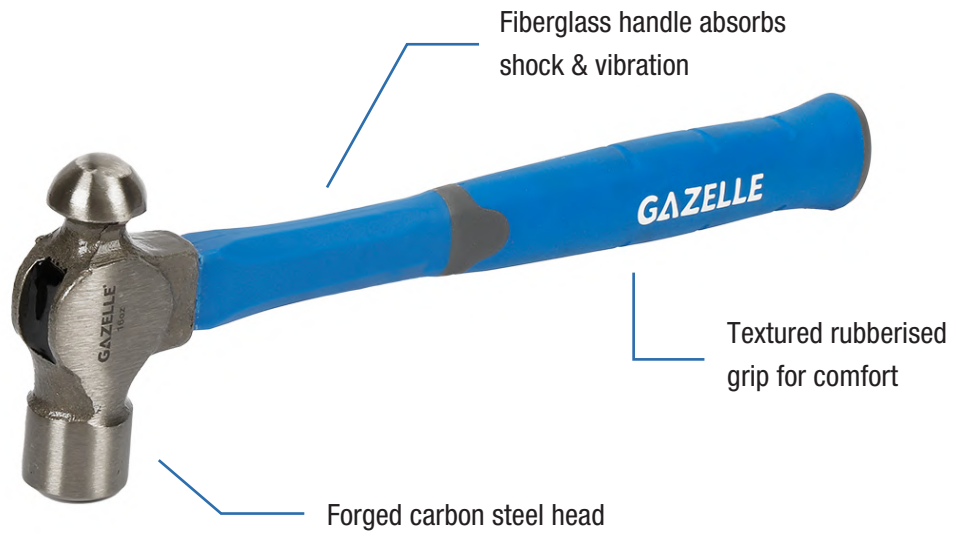

SKU	SKU Description
G80169	16 oz Ball Pein Hammer with Fiberglass Handle
G80170	24 oz Ball Pein Hammer with Fiberglass Handle

## Club Hammer w/ Fiberglass Handle



SKU	SKU Description
G80168	2.5 lbs. Club Hammer with Fiberglass Handle

## Rubber Mallet w/ Hardwood Handle



SKU	SKU Description
G80214	16 oz Rubber Mallet with Hardwood Handle

## Curved Claw Hammers w/ Fiberglass Handle

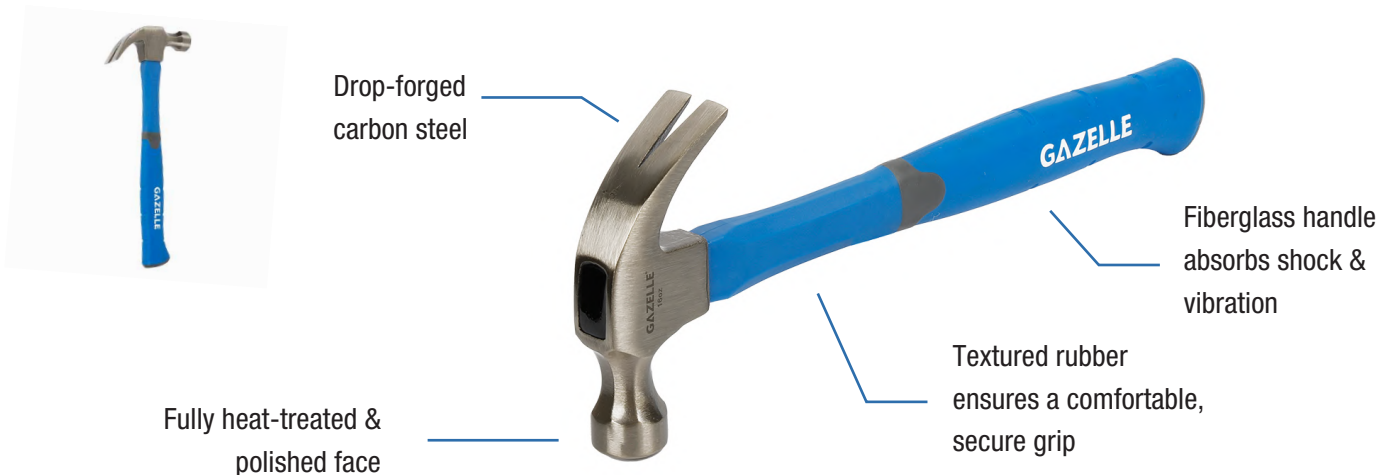

SKU	SKU Description
G80166	16 oz Curved Claw Hammer with Fiberglass Handle
G80167	20 oz Curved Claw Hammer with Fiberglass Handle

## Dead Blow Hammer



SKU	SKU Description
G80215	1.5 lbs. Dead Blow Hammer

## Demolition Bar

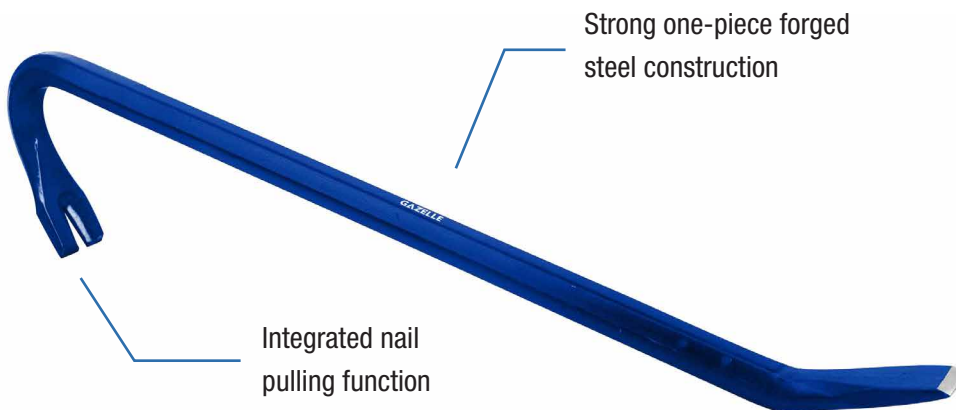

SKU	SKU Description
G80216	36" (900 mm) Demolition Bar

## 3-in-1 Automatic Wire Stripping Tool

3-in-1 Tool Allowing Cutting, Stripping and Crimping

Strong-gripping serrated nose

Non-slip cushion-grip handle



Cuts and threads popular bolt sizes

Wire looping and bending holes

Curved handles help you reach into confined areas

SKU	SKU Description
G80160	3-in-1 Automatic Wire Stripping Tool

## Ratcheting Bar Clamps

Quickly converts from a clamp to a spreader without the use of tools

Soft padded jaws to protect work piece



Reinforced nylon construction

SKU	SKU Description
G80211	12" (300 mm) Heavy Duty Ratcheting Bar Clamp
G80212	18" (460 mm) Heavy Duty Ratcheting Bar Clamp
G80213	24" (610 mm) Heavy Duty Ratcheting Bar Clamp

## Tubing Cutter



SKU	SKU Description
G80225	1/8"- 1-1/4" (3-32 mm) Tubbing Cutter

## Pipe Cutter



SKU	SKU Description
G80226	1-5/8" (42 mm) Pipe Cutter

## General Purpose C-Clamps

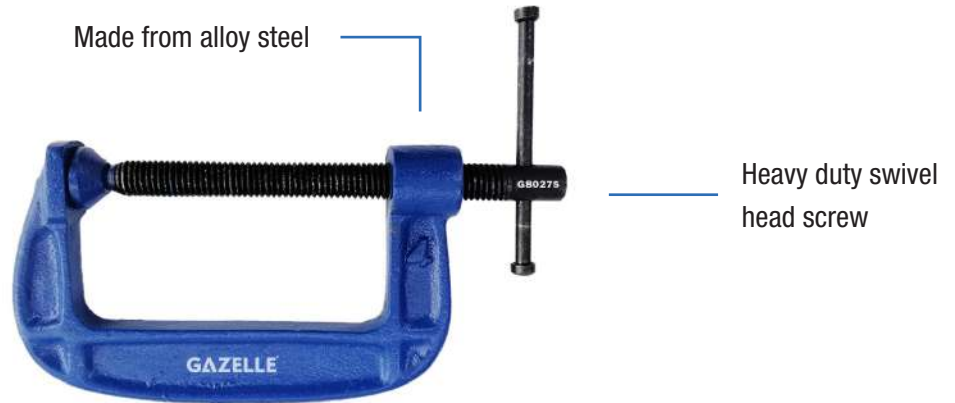

SKU	SKU Description
G80275	4" General Purpose C-Clamp
G80276	6" General Purpose C-Clamp
G80277	8" General Purpose C-Clamp
G80278	10" General Purpose C-Clamp
G80279	12" General Purpose C-Clamp

## Aluminum Frame Torpedo Level

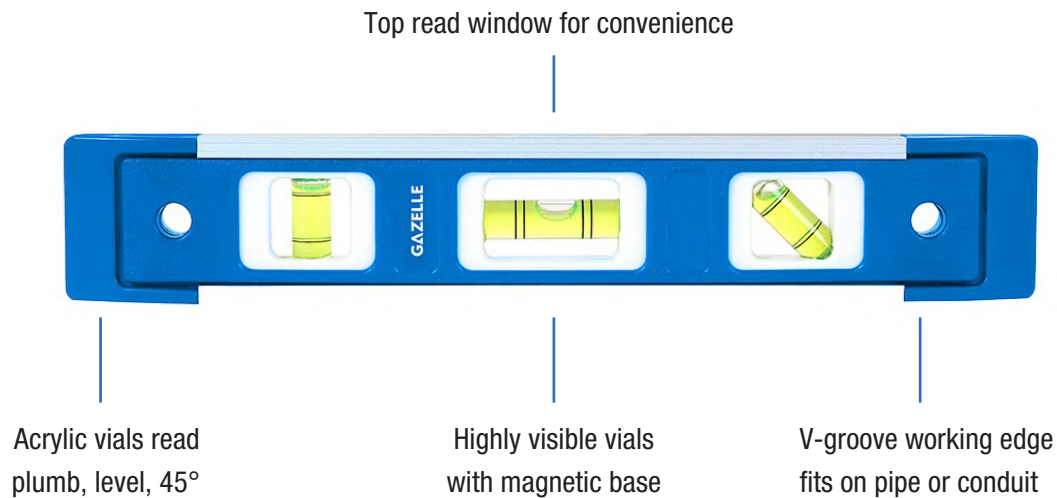

SKU	SKU Description
G80220	9" Aluminum Frame Torpedo Level

## Magnetic Aluminum Box Levels

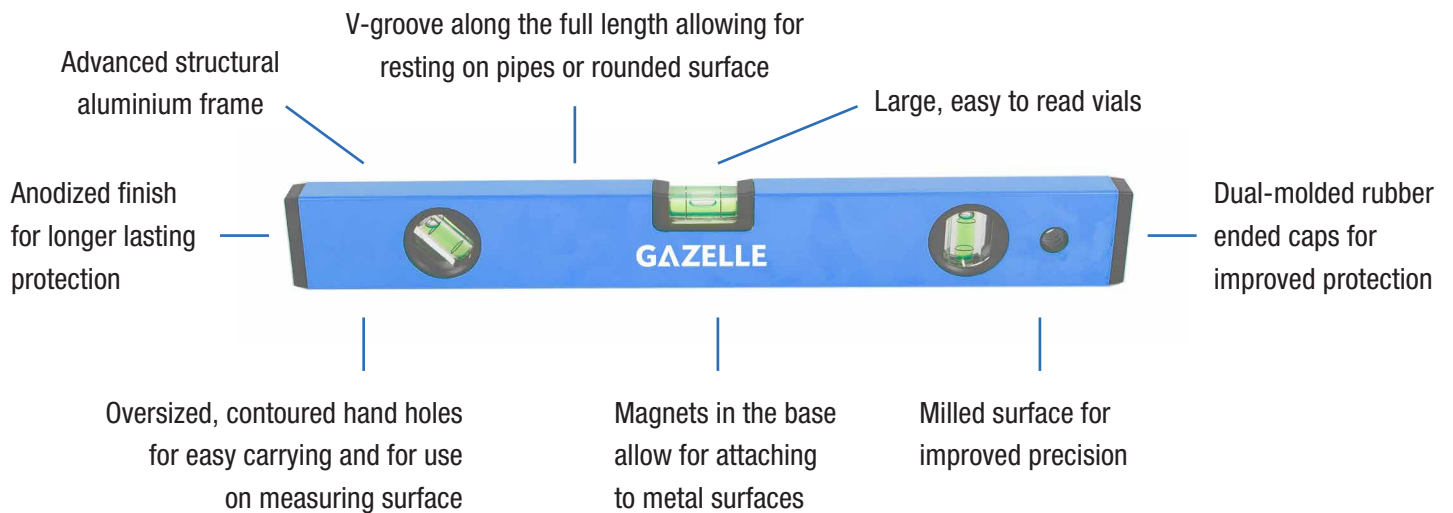

SKU	SKU Description
G80221	12" (300 mm) Magnetic Aluminum Box Level
G80222	24" (600 mm) Magnetic Aluminum Box Level
G80223	48" (1200 mm) Magnetic Aluminum Box Level

## Aluminum Magnetic Box Level



SKU	SKU Description
G80376	400mm (16") Aluminum Magnetic Box Level
G80377	600mm (24") Aluminum Magnetic Box Level
G80378	1000mm (40") Aluminum Magnetic Box Level

## Aluminum Box Level



SKU	SKU Description
G80379	300mm(12") Aluminum Magnetic Box Level
G80380	600mm(24") Aluminum Magnetic Box Level
G80381	1000mm(40") Aluminum Magnetic Box Level
G80382	1800mm (72"); Accuracy 1.5‰ Aluminum Magnetic Box Level
G80383	2000mm (80"); Accuracy 1.5‰ Aluminum Magnetic Box Level

## Mitre Box 45° & 90° Cutting Angles



SKU	SKU Description
G80209	Mitre Box 45° & 90° Cutting Angles

## Bolt Cutters

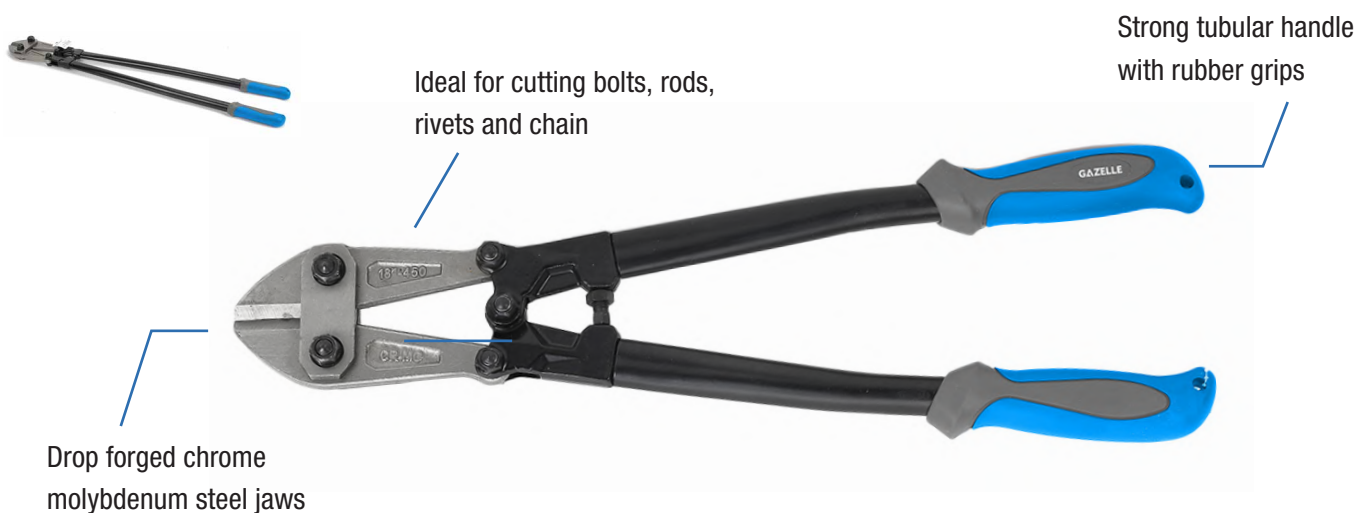

SKU	SKU Description
G80201	14" (350 mm) Bolt Cutter
G80202	18" (450 mm) Bolt Cutter
G80203	24" (600 mm) Bolt Cutter
G80204	30" (750 mm) Bolt Cutter
G80205	36" (900 mm) Bolt Cutter

## Inside Calipers



SKU	SKU Description
G80260	6" Inside Caliper
G80261	8" Inside Caliper
G80258	10" Inside Caliper
G80259	12" Inside Caliper

## Outside Calipers



SKU	SKU Description
G80264	6" Outside Caliper
G80265	8" Outside Caliper
G80262	10" Outside Caliper
G80263	12" Outside Caliper

## Spring Dividers



SKU	SKU Description
G80266	6" Spring Divider
G80267	8" Spring Divider

## Vernier Caliper

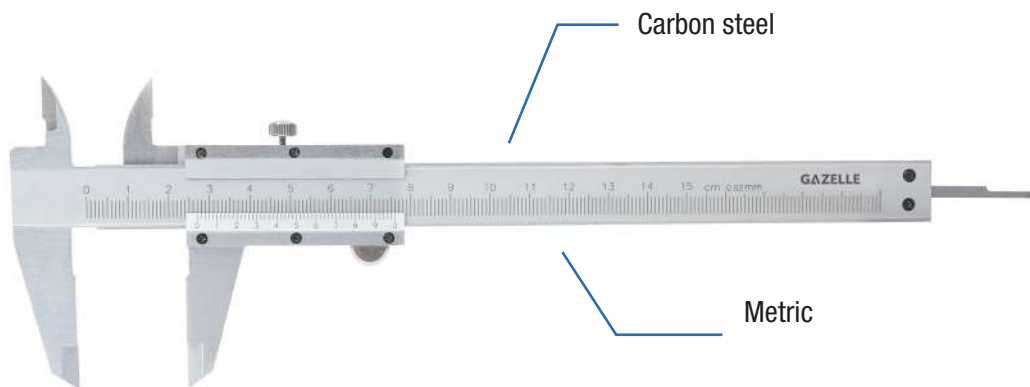

SKU	SKU Description
G80224	6" (150 mm) Vernier Caliper

## Digital Vernier Caliper



SKU	SKU Description
G80296	6" (150mm) Digital Vernier Caliper

## Fiberglass Measuring Tapes



SKU	SKU Description
G80294	30m Fiberglass Measuring Tape
G80295	50m Fiberglass Measuring Tape

## 5-piece Wood Chisel Set

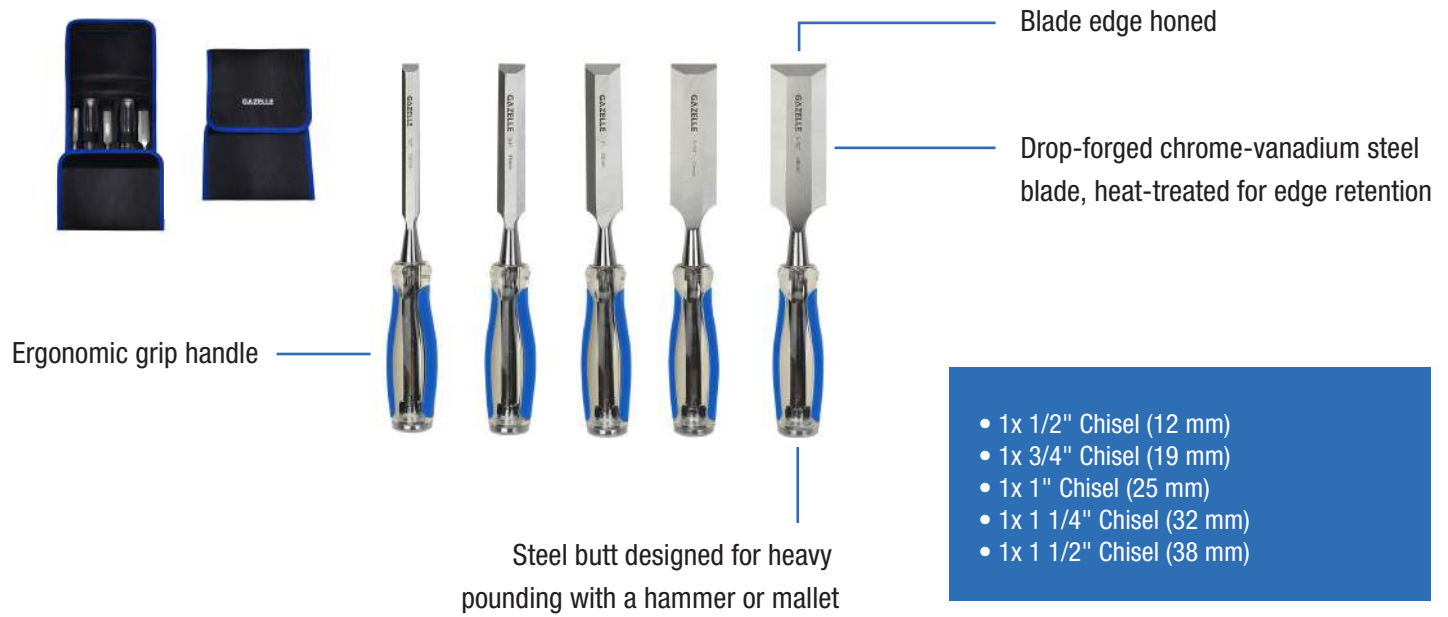

SKU

G80372

SKU Description

5-pc. Wood Chisel Set

## Block Planer

Professional woodworkers jack plane features wooden handle and knob



High carbon steel blade is fitted with adjustable screw for setting the depth of cut

Made of high quality cast iron steel body ground on side and base

SKU

SKU Description

G80255

6-1/4" Block Planer

## Smoothing Bench Plane

Professional woodworkers jack plane features wooden handle and knob



High carbon steel blade is fitted with adjustable screw for setting the depth of cut

No. 4 Wooden Handle

Smooth Base

Made of high quality cast iron steel body ground on side and base

SKU

SKU Description

G80256

10" Smoothing Bench Plane

## Heavy Duty Jack Bench Plane

Professional woodworkers jack plane features wooden handle and knob



No. 5 Wooden Handle

High carbon steel blade is fitted with adjustable screw for setting the depth of cut

Smooth Base

Made of high quality cast iron steel body ground on side and base

SKU	SKU Description
G80257	14" Heavy Duty Jack Bench Plane

## Bench Vises w/ Anvil

Hardened and tempered jaws



Stationary ductile iron base with lacquered surface

SKU	SKU Description
G80235	8" Bench Vise Fix with Anvil
G80236	4" Bench Vise Swivel with Anvil
G80237	6" Bench Vise Swivel with Anvil

## Wood Working Vises

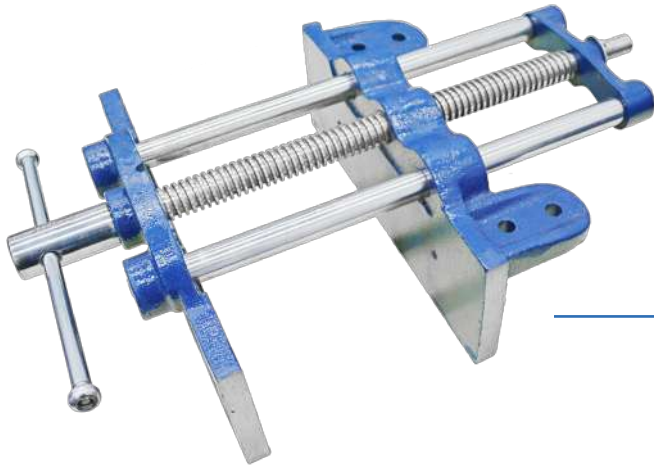

Quick Release

- G80343**  
 Jaw Width: 7in (178mm)  
 Jaw Opening: 6 1/4in (160mm)  
 Net Weight: 7lbs (3kg)
- G80344**  
 Jaw Width: 9in (228mm)  
 Jaw Opening: 9in (228mm)  
 Net Weight: 14.4lbs (6.250kg)

SKU	SKU Description
G80343	7" Wood Working Vise
G80344	9" Wood Working Vise

## 100mm Precision Unigrip Vise

Used for drilling, tapping & reaming applications

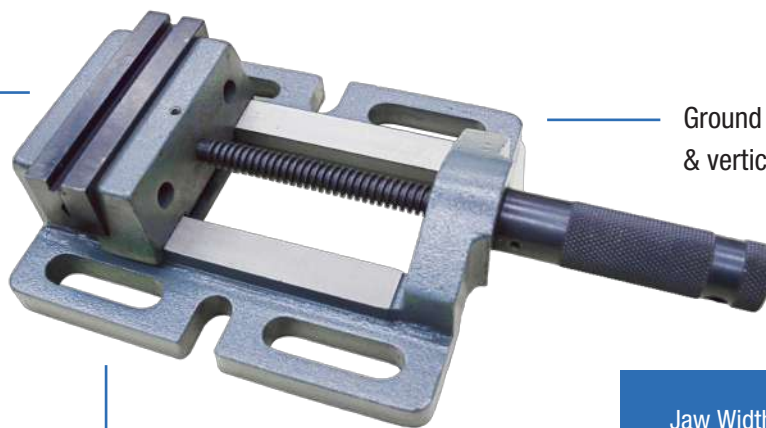

Ground jaws with horizontal & vertical vees

Cast iron construction with precision ground base & slide

Jaw Width: 4in (100mm)  
 Jaw Opening: 4in (100mm)  
 Jaw Depth: 1 3/8in (35mm)

SKU	SKU Description
G80345	100mm Precision Unigrip Vise

## Super Value Grease Gun w/ Flexible Hose & Coupler



SKU	SKU Description
G80268	500 cm <sup>3</sup> Super Value Lever Grease Gun with Flexible Hose & Coupler

## Super Value Lever Grease Gun w/ Steel Extension & Coupler



SKU	SKU Description
G80269	500 cm <sup>3</sup> Super Value Lever Grease Gun with Steel Extension & Coupler

## Heavy Duty Lever Grease Gun w/ Steel Extension & Coupler



Die cast head incorporates bulk loader and Air bleeder valve

Loading the grease gun is easy and convenient using a cartridge



The sturdy build of the product makes it long-lasting and prevents accidental spills

Jam-proof lever and spring action - Easy to operate without any hiccups

Comes with steel extension and 4 jaw coupler with ball check

SKU	SKU Description
G80270	500 cm <sup>3</sup> Heavy Duty Lever Grease Gun with Steel Extension & Coupler

## Pistol Grip Grease Gun w/ Steel Extension & Coupler



Aluminum Die Cast Head is solidly constructed for long life

Loading the grease gun is easy and convenient using a cartridge

Comes with 4 in. steel extension and 4 jaw coupler



The pistol grip allows for easy one-handed operation

Aluminum Die-cast head incorporates Bulk loader and Air Bleeder valve

Makes it sturdy and durable

The tool can withstand accidental drops

The grease flows out smoothly without any difficulties

SKU	SKU Description
G80271	500 cm <sup>3</sup> Pistol Grip Grease Gun with Steel Extension & Coupler

## Heavy Duty Bucket Grease Pump w/ Wheels

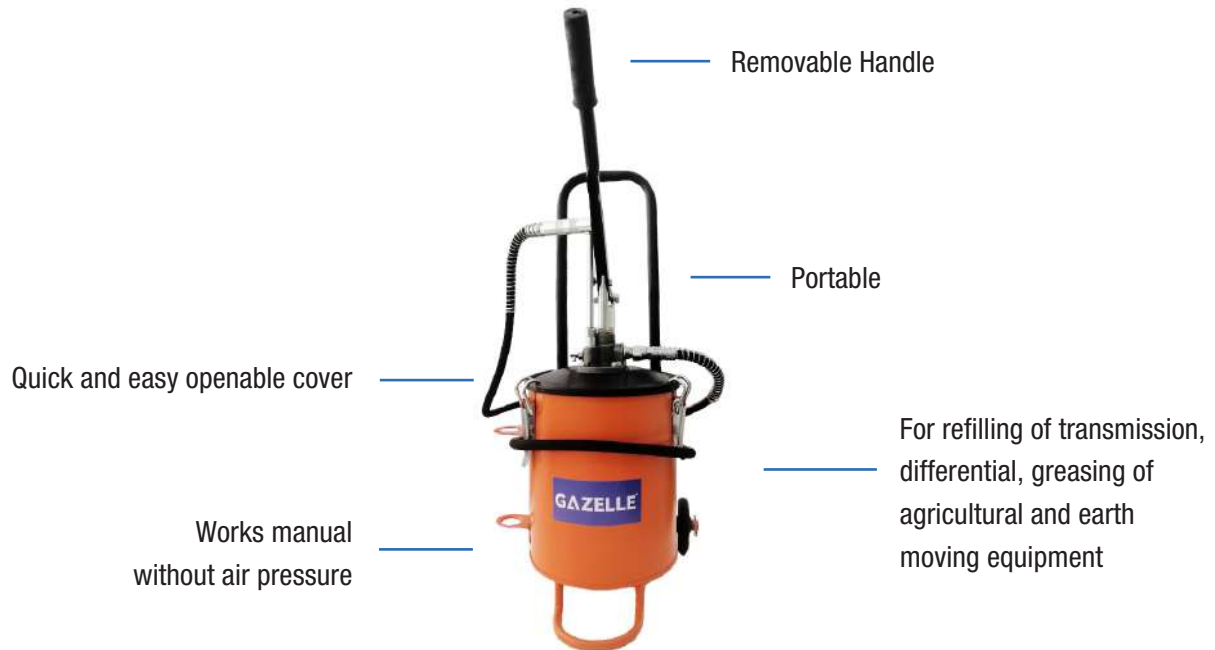

SKU	SKU Description
G80272	10 kg. Heavy Duty Bucket Grease Pump with Wheels

## High Pressure Foot Operated Grease Pump



SKU	SKU Description
G80341	High Pressure Foot Operated Grease Pump

## Rotary Barrel Plastic Pump

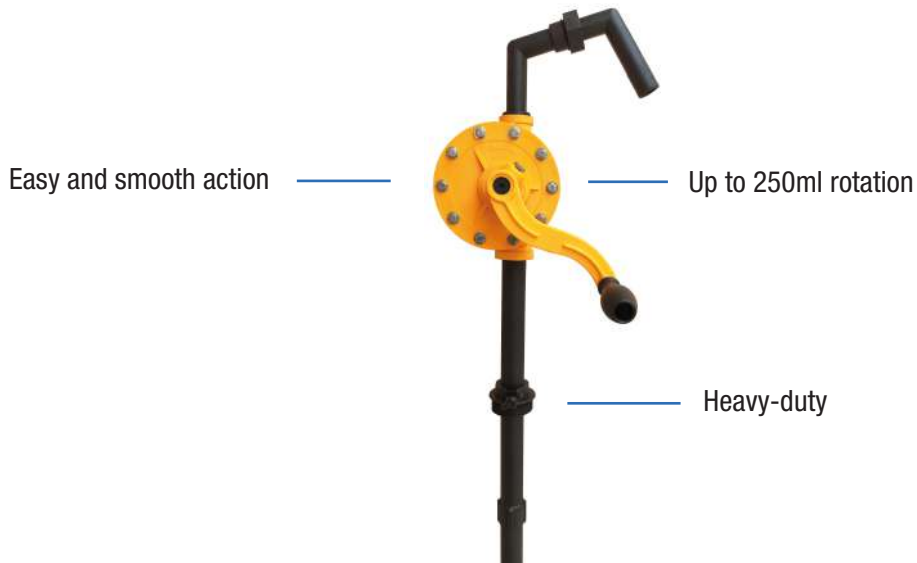

SKU	SKU Description
G80342	Rotary Barrel Plastic Pump

## Inlet Rotary Barrel Steel Pump



SKU	SKU Description
G80273	1" Inlet Rotary Barrel Steel Pump

## Lever Action Barrel Pump

Telescoping steel tube made of steel,  
used for oil based fluids, heating oils,  
motor oils, heavy & light oils,  
Diesel & Kerosene

Pump not suited for use with water



With ribbed section cast pump head,  
fits 50-210 L drums

Steel pump body includes curved  
discharge metal pipe and  
telescoping steel tube assembly

**SKU**

**G80274**

**SKU Description**

50-210L Lever Action Barrel Pump

## Professional Conduit/Pipe Bender

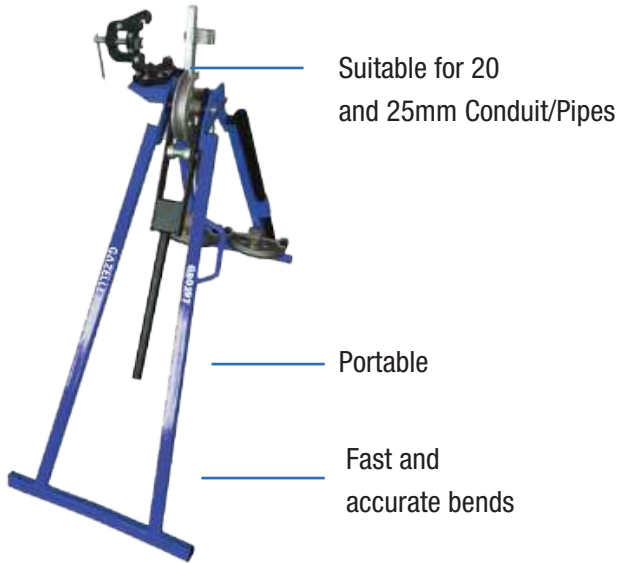

- Bending Level
- Handle Extension Tube
- Bending Former 20mm
- Bending Former 25mm
- Complete Pipe Vice
- Lower Vice Jaw
- Stop Block
- Stop Block Bar
- Cotter Pin
- Pivot Pin
- Grooved Roller
- Center Pin
- Support
- Main Body
- Special Bolt
- Flat Washer 12mm
- Inside Spacer Sleeve
- Outside Spacer Sleeve
- Lock Nut M12-1.75
- Chain with Ring
- Grooved Roller Pin
- Hex Bot M8-1.25x25
- Flat Washer 8mm
- Hex Nut M8-1.25

SKU	SKU Description
G80297	Professional Conduit/Pipe Bender

## 20-25mm Conduit Die Set



- Die for 20mm
- Die for 25mm
- Die Guide for 20mm
- Die Guide for 25mm
- Die Stock per set with detachable handle

SKU	SKU Description
G80298	20-25mm Conduit Die Set

## 3-in-1 Tube & Pipe Bender

Max Bending Radius:  
180 degree



Bending applications: soft copper,  
aluminum and brass tubing

Max Bending Capacity-Round (In. dia.):  
1/4", 5/16", 3/8" (6 mm, 8 mm, 10 mm)

SKU	SKU Description
G80227	3-in-1 Tube & Pipe Bender (1/4", 5/16", 3/8")

## Heavy Duty Tubing Bender

Max Bending Radius:  
180 degree



Bending applications: copper tubing,  
aluminum tubing, soft metal tubing

Max Bending Capacity-Round (In. dia.):  
16mm, 22mm

SKU	SKU Description
G80228	Heavy Duty Tubing Bender (19/32", 7/8")

## 51-Piece Drill Accessory Set



- 9 Pcs. HSS Twist Drills: 1.5, 2, 2.5, 3, 3.5, 4, 5, 6, 6.5 mm
- 6 Pcs. Masonry Drills: 3, 4, 5, 6, 8, 10 mm
- 5 Pcs. Wood Drills: 4, 5, 6, 8, 10 mm
- 1 Pc. Centre Punch
- 1 Pc. Countersink
- 1 Pc. Magnetic Bit Holder
- 20 Pcs. 25 mm Screwdriver Bits
  - 7 Pcs. Slotted: 3, 4x2, 5x2, 6, 7 mm
  - 6 Pcs. Philips: PH0, PH1x2, PH2x2, PH3
  - 3 Pcs. Pozi: PZ1, PZ2, PZ3
  - 4 Pcs. Star: T10, T15, T20, T25
- 6 Pcs. 1/4" Socket: 5, 6, 7, 8, 9, 10 mm
- 1 Pc. 1/4" Adapter
- 1 Pc. Carry Case

SKU	SKU Description
G80232	51-Pc. Drill Accessory Set

## SAE Flaring Tool

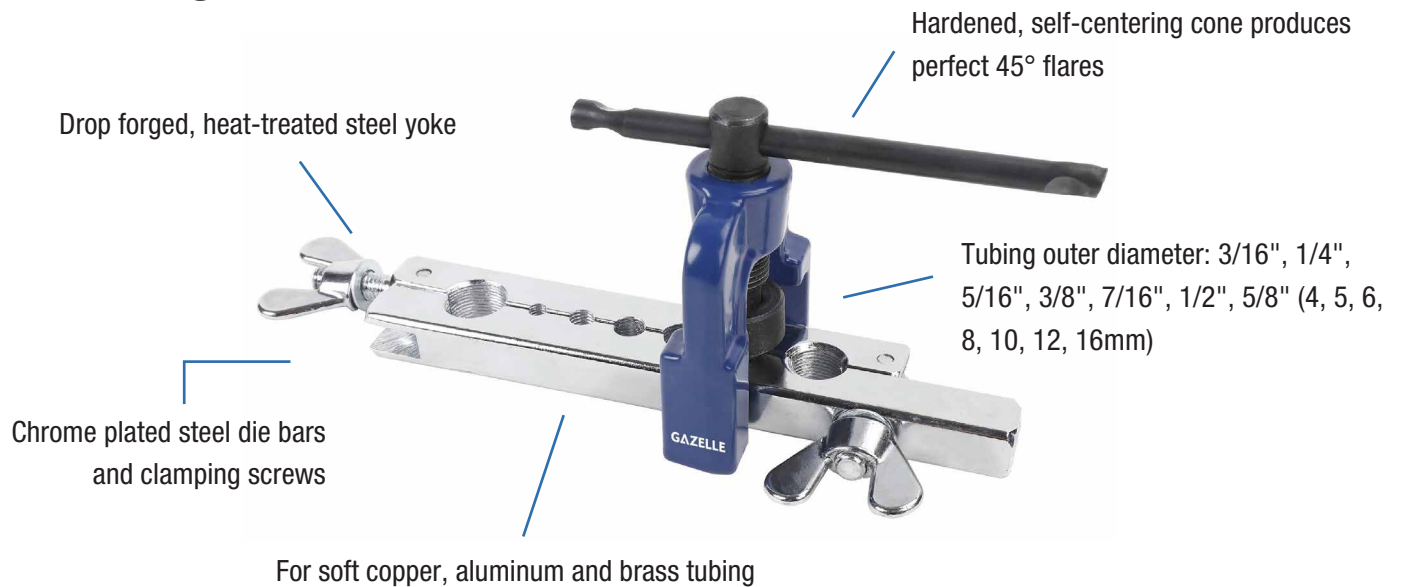

SKU	SKU Description
G80229	SAE Flaring Tool

## Tap and Die Set



Alloy steel heat treated for durability



Iron Box for convenient storage

### G80374 Tap and Die Set

- 1pc M3 x 0.5 Die
- 1pc M4 x 0.7 Die
- 1pc M5 x 0.8 Die
- 1pc M6 x 1.0 Die
- 1pc M8 x 1.25 Die
- 1pc M10 x 1.5 Die
- 1pc M12 x 1.75 Die
- 3pc M3 x 0.5 Tap
- 3pc M4 x 0.7 Tap
- 3pc M5 x 0.8 Tap
- 3pc M6 x 1.0 Tap
- 3pc M8 x 1.25 Tap
- 3pc M10 x 1.5 Tap
- 3pc M12 x 1.75 Tap
- 1pc Tap Wrench
- 1pc Die Stock
- 1pc Pitch Gauge
- 1pc Screwdriver

SKU

G80374

SKU Description

32-pc. Tap and Die Set

## 70-Piece 1/4" Drive Socket Set



- **1/4 Drive: 10 Pcs. 6 pt. SAE Socket:**  
5/32", 3/16", 7/32", 1/4", 9/32", 5/16", 11/32", 3/8", 7/16", 1/2"
- **1/4 Drive: 10 Pcs. 6 pt. Metric Socket:**  
5 mm, 5.5 mm, 6 mm, 7 mm, 8 mm, 9 mm, 10 mm, 11 mm, 12 mm, 13 mm
- **1/4 Drive: 6 Pcs. 6 pt. SAE Deep Socket:**  
1/4", 9/32", 5/16", 11/32", 3/8", 7/16"
- **1/4 Drive: 6 Pcs. 6 pt. Metric Deep Socket:**  
6 mm, 7 mm, 8 mm, 9 mm, 10 mm, 11 mm
- 1 Pc. 1/4" Universal Joint
- 12 Pcs. Nut Driver
- 1 Pc. 1/4" Dr. Coupler
- 1 Pc. 1/4" 3" Extension Bar
- 1 Pc. 1/4" 6" Extension Bar
- 1 Pc. 1/4" Dr. Quick Release Ratchet Handle 45T
- 1 Pc. 1/4" Dr. Spinner Handle
- 20 Pcs. Bits with Holder

**SKU**

**G80233**

**SKU Description**

70-pc 1/4" Drive Socket Set

## 30-Piece 1/2" Drive Socket Set



- **1/2 Drive: 12 Pcs. 6 pt. SAE Socket:**  
5/16", 3/8", 7/16", 1/2", 9/16", 5/8", 11/16", 3/4", 13/16", 7/8", 15/16", 1"
- **\*1/2 Drive: 14 Pcs. 6 pt. Metric Socket:**  
8 mm, 9 mm, 10 mm, 11 mm, 12 mm, 13 mm, 14 mm, 15 mm, 16 mm, 17 mm, 18 mm, 19 mm, 20 mm, 21 mm
- 1 Pc. 1/2" Dr. Universal Joint
- 1 Pc. 1/2" 3" Extension Bar
- 1 Pc. 1/2" 5" Extension Bar
- 1 Pc. 1/2" Dr. Quick Release Ratchet Handle 45T

**SKU**

**G80234**

**SKU Description**

30-pc 1/2" Drive Socket Set

## 24-piece Metric Socket Set



- 17pcs short socket: 8, 10, 12, 13, 14, 15, 16, 17, 18, 19, 21, 22, 23, 24, 27,30, 32mm
- 1/2"X 3" Extension bar
- 1/2"X 5" Extension Bar
- 1/2 universal joint
- 2 pcs Spark Socket 5/8"(16mm), 13/16" (21mm)
- 1/2 Ratchet handle, 72 teeth-255mm
- 1/2 Dr. Breaker-375mm

**SKU**

**G80288**

**SKU Description**

24-pc Metric Socket Set

## 45-Piece Tool Set



- 3 Pcs. 6" Pliers
- 1 Pc. 6" Adjustable Wrench
- 1 Pc. Magnetic Bit Holder
- 32 Pcs. Bits + 1 Pc. Extension Bar
- 6 Pcs. Screwdriver
- 1 Pc. Utility Knife

SKU	SKU Description
G80230	45-pc. Tool Set

## 188-Piece Tool Set



- 1 Pc. Utility Knife
- 10 Pcs. Utility Knife Blade
- 10 Pcs. Screwdriver
- 1 Pc. Magnet Bit Holder
- 40 Pcs. 1" CR-V Bits
- 1 Pc. 16 oz Curved Claw Hammer
- 4 Pcs. Pliers
- 1 Pc. 8" Adjustable Wrench
- 1 Pc. 3/8" Dr. Quick Release Ratchet Handle
- 16 Pcs. 3/8" Sockets
- 1 Pc. 3/8" 3" Extension Bar
- 85 Pcs. Hardware Kits
- 1 Pc. 10" Tool Bag
- 16 Pcs. Hex Key Set

SKU	SKU Description
G80231	188-pc. Tool Set

## Oil Cans w/ Rigid and Flexible Spouts



Comes with rigid and flexible spouts



Brass Pump

WS Type

SKU	SKU Description
G80280	6oz (200ml) Brass Pump Oil Can w/ Rigid And Flexible Spouts
G80281	10oz (300ml) Brass Pump Oil Can w/ Rigid And Flexible Spouts

INNOVATION  
PERFORMANCE  
SAFETY  
CONFIDENCE  
GAZELLE

**GAZELLE®**

[sales@gazelleindustrial.com](mailto:sales@gazelleindustrial.com) | [www.gazelleindustrial.com](http://www.gazelleindustrial.com)