



TEST & MEASUREMENTS



Scan for video

Palm Size Multimeter, 10A

G9100 Series - G9101

The GAZELLE G9101 is a palm size, compact easy-to-use digital multimeter designed for your everyday troubleshooting jobs on the site. This multimeter is independently tested for safe use in CAT II 600V environments, delivering reliable measurements time after time without any compromise to your safety.



- Designed for basic electrical tests to measure DC Voltage, AC Voltage, Ohms, Continuity, Diode, Temperature, DC Current
- Large, backlit display for easy visibility in low-lit work environments
- CAT II 600V safety rating
- Rubber holster for extra protection

Standard Accessories

- User Manual
- Test Lead
- K-Type Thermocouple

Specifications	Range	Best Accuracy
DC Voltage (V)	200mV/600V	±(0.5%+2)
AC Voltage (V)	200V/600V	±(1.2%+3)
DC Current (A)	2000uA/10A	±(1.0%+2)
Resistance(Ω)	200Ω/20MΩ	±(0.8%+2)
Temperature (°C)	-40°C/1000°C	±(1.0%+4)
Temperature (°F)	-40°F/1832°F	±(1.5%+5)
Drop Test		2m
Diode		√
Overload Protection		Display OL
Data Hold		√
Low Battery Indication		√
SLEEP		√
LCD Backlight		√
Power	1.5V AAA 2PCS	√
Product Size	134 X 76.5 X 47 mm	



Scan for video

Digital Multimeter, 10A

G9100 Series - G9102

The GAZELLE G9102 Digital Multimeter is designed for professional applications. With AC/DC measurement capabilities tested for safe use in CAT III 600V environments, the G9102 is designed for daily maintenance and troubleshooting activities with a 2-metre drop test. Additionally, a low pass filter supports accurate frequency measurements on Variable Frequency Drive (VFDs) signals.



- Safe, accurate, multi-function digital multimeter with AC/DC measurement capabilities
- Big LCD display with bright white backlight for a clear view of measurement
- Rugged build tested to withstand 2 metres drop
- NCV voltage detectors for safety verification
- With a Thermocouple probe for temperature measurements

Standard Accessories

- Operating Manual
- Test Lead
- K-Type Thermocouple

Specifications	Range	Best Accuracy
DC Voltage	400mV/1000V	±(0.5%+5)
AC Voltage	4V/750V	±(0.8%+3)
AC Current	4mA/10A	±(1.0%+2)
DC Current	400uA/10A	±(0.8%+3)
Resistance(Ω)	400MΩ/40MΩ	±(0.8%+2)
Capacitance	4nF/10mF	±(4%+5)
Frequency	10Hz~1MHz	±(0.1%+4)
Temperature (°C)	-40~1000°C or -40~1832°F	±(1.0%+4)
Features		
Auto Range		x
NCV		√
Diode Test		√
Continuity Test		√
Backlight		√
Operation Temperature		0°C~40°C
Safety Rating		CAT II 1000V/CAT III 600V
True RMS		x



Scan for video

True RMS Multimeter, 10A

G9100 Series - G9103

The GAZELLE G9103 True RMS Multimeter is designed for professional and industrial applications. With AC/DC measurement capabilities tested for safe use in CAT III 600V environments, the G9103 is designed for daily maintenance and troubleshooting activities with a 2-metre drop test. Additionally, a low pass filter supports accurate frequency measurements on Variable Frequency Drive (VFDs) signals.



- Safe, accurate, multi-function True RMS digital multi meter with AC/DC measurement capabilities
- Big LCD display with bright white backlight for a clear view of measurement
- Rugged build tested to withstand 2 metres drop
- NCV voltage detectors for safety verification
- With a Thermocouple probe for temperature measurements

Standard Accessories

- Operating Manual
- Test Lead
- K-Type Thermocouple

Specifications	Range	Best Accuracy
DC Voltage	60mV/600V	±(0.5%+2)
AC Voltage	60mV/600V	±(0.8%+3)
AC Current	600uA/10A	±(0.7%+2)
DC Current	600uA/10A	±(1.0%+3)
Resistance(Ω)	600Ω/60MΩ	±(0.8%+2)
Capacitance	9.999NF/99.99MF	±(4.0%+5)
Frequency	10HZ/10MHZ	±(0.1%+4)
Temperature (°C)	-40/1000°C	±(1.0%+3)
	-40/1832°F	±(1.5%+5)
Features		
Auto Range		√
NCV		√
Diode Test		About 3V
Continuity Test		√
Backlight		√
Operation Temperature		0°C~40°C
Safety Rating		CAT II 1000V/CAT III 600V
True RMS		√



Scan for video

Mini Clamp Meter, 200A

G9200 Series - G9201

The compact GAZELLE G9201 Mini Clamp Meter, 200A is ergonomically designed to meet your needs. The reduced dimensions of this device allow for measurements to be taken in places with limited access. With features of AC current measurements up to 200A, a 16mm jaw opening and a CAT II 600V/CAT III 300V safety rating, the G9201 is the ideal compact clamp meter to check your load! This mini clamp meter is useful for troubleshooting tasks in plant maintenance, electrical, HVAC, and telecom work, as well as residential electrical, fleet maintenance, marine, and motorcycle repairs.



- High reliability, safety, and compact design
- 200A full range overload protection for additional safety during measurement
- CAT III 300 V/CAT II 600 V safety rating
- Big LCD display with bright white backlight for clear view of measurement
- Averaging type clamp meter (effective sine wave value)

Standard Accessories

- Operating Manual
- 1.5V AAA Battery -2pcs

Specifications	Range
AC Current (A)	2A/20A/200A ($\pm 2.5\% + 20$)
Features	
Display Count	2000
Auto Range	√
Jaw Capacity	16 mm
Auto Power Off	Around 15 minutes
Low Battery Indic.	$\leq 2.5V$
Data Hold	√
Max Hold	√
LCD Backlight	√
Input Protection	√
Power	AAA 1.5V x 2
LCD Size	39.3mm x 26.5mm
Net Weight	150g
Size	158mm x 60mm x 33.5 mm



Scan for video

True RMS Clamp Meter, 400A

G9200 Series - G9202

The GAZELLE G9202 True RMS Clamp Meter, 400A is a reliable, versatile troubleshooting tool used to diagnose a wide range of electrical issues in commercial and industrial applications. The G9202 measures AC/DC voltage, AC current, resistance, capacitance, continuity, and frequency to fulfil the daily tasks on the job site. For quick and easy testing of electrical lines, the G9202 is also equipped with non-contact voltage detection and is tested for safe use in CAT III 600V environments. With the ergonomic design and large backlight LCD display, the G9202 is every technician's go-to tool for their electrical testing requirements.



- TRMS measurement, AC/DC Voltage and AC current measurement
- Multi-function capable of resistance, diode, continuity, and frequency measurements
- Big LCD display with a clear white backlight for measurement in dark areas
- Includes a built-in torch for dark electrical panel
- NCV voltage detectors for safety verification
- Includes Gazelle branded carrying case

Standard Accessories

- Operating Manual
- Carrying Case
- Test Lead

Specifications	Range	Best Accuracy
AC Current (A)	4A/40A/400A	±(1.8%+9)
AC Voltage (V)	4V/40V/400V/600V	±(1.2%+5)
DC Voltage (V)	400mV/4V/40V/400V/600V	±(0.8%+1)
Resistance (Ω)	400Ω/4kΩ/40kΩ/400kΩ/4MΩ/40MΩ	±(1.0%+2)
Capacitance (F)	50nF/500nF/5μF/50μF/100μF	±(4.0%+5)
Frequency	10Hz~1MHz	±(0.1%+4)
Features		
Auto Range		√
Jaw Capacity		30mm
Diode Around		1.5V
NCV		√
Data Hold		√
Relative Mode		√
LCD Backlight		√
Flashlight		√
Auto Power Off		√
Continuity Buzzer		√
Low Battery Indication		≤2.4V
Input Protection		√
Input Impedance for DCV		≥10MΩ



Scan for video

True RMS Clamp Meter, 600A

G9200 Series - G9203

The GAZELLE G9203 True RMS Clamp Meter, 600A is a reliable, versatile troubleshooting tool used to diagnose a wide range of electrical issues in commercial and industrial applications. The G9203 measures AC/DC voltage, AC current, resistance, capacitance, continuity, and frequency to fulfil the daily tasks on the job site. For quick and easy testing of electrical lines, the G9203 is also equipped with non-contact voltage detection and is tested for safe use in CAT III 600V environments. With the ergonomic design and large backlight LCD display, the G9203 is every technician's go-to tool for their electrical testing requirements.



- TRMS measurement AC/DC Voltage and AC current measurement
- Multi-function capable of resistance, diode, continuity, and frequency measurements
- Big LCD displays a clear white backlight for measurement in dark areas
- Includes a built-in torch for dark electrical panel
- NCV voltage detectors for safety verification
- Includes Gazelle branded carrying case

Standard Accessories

- Operating Manual
- Carrying Case
- Test Lead

Specifications	Range	Best Accuracy
AC Current (A)	6A/60A/600A	±(2.5%+5)
AC Voltage (V)	6V/60V/600V/750V	±(1.2%+5)
DC Voltage (V)	600mV/6V/60V/600V/1000V	±(0.8%+1)
Resistance (Ω)	600Ω/6kΩ/60kΩ/600kΩ/6MΩ/60MΩ	±(1%+2)
Capacitance (F)	99.99nF/999.9nF/9.999μF/99.99μF/	±(4.0%+5)
Frequency	999.9μF/9.999mF/60mF	
Features		
Auto Range		√
Jaw Capacity		30mm
Diode Around		Around 3.0V
NCV		√
Data Hold		√
Relative Mode		√
LCD Backlight		√
Flashlight		√
Auto Power Off		√
Continuity Buzzer		√
Low Battery Indication		≤3.6V
Input Protection		√
Input Impedance for DCV		≥10MΩ

True RMS Clamp Meter, 1000A

G9200 Series - G9204-II

The GAZELLE G9204-II 1000A True RMS Clamp Meter is a rugged and compact instrument that allows users to measure current up to 1000A and voltage up to 1000 Volts. This high-frequency response range is well-suited for engineers and technicians to measure more applications. The ergonomically designed double-moulded housing offers a better grip for one-hand operation, with a large 4000-count LCD display with bright backlighting allowing users to read measurements in dim light. The dual-mode NCV allows users to detect live voltages without contacting any metallic surface. In addition to AC Current, the G9204-II can measure AC/DC voltage, resistance, capacitance, frequency, and temperature. This meter is CE/UKCA approved and features a CATII 1000V / CATIII 600V safety rating with 1000V overload protection.



- True RMS
- 1000V AC/DC voltage measurement
- 60MΩ resistance measurement
- Large LCD with backlight
- ACA frequency measurement: 20Hz~10kHz
- 1000V overload protection
- NCV (High/Low dual-mode)

Standard Accessories

- 1 pair Test Leads
- AAA 1.5V batteries x 2
- Carrying bag
- User Manual

Specifications	Range	Best Accuracy
AC Current (A)	1000A	±(1.5%+4)
ACA Frequency (Hz)	20Hz~10kHz	±(1.0%+5)
AC voltage (V)	1000V	±(1.0%+2)
DC Voltage (V)	1000V	±(0.7%+3)
Resistance (Ω)	60MΩ	±(0.8%+2)
Capacitance (F)	6mF	±(4%+5)
Features		
Display count		6000
Jaw opening		33mm
Auto range		√
True RMS		√
Diode Test		√
NCV		√
Data hold		√
LCD backlight		√
Auto power off		Around 15 minutes
Continuity buzzer		√
Low battery indication		≤2.5V
Input protection		√
Input impedance for DCV		≥10MΩ



Scan for video

Digital Clamp Meter, 1000A

G9200 Series - G9204

The GAZELLE G9204 Clamp Meter, 1000A is a reliable, versatile troubleshooting tool used to diagnose a wide range of electrical issues in commercial and industrial applications. The G9204 measures AC/DC voltage, AC current, resistance, capacitance, continuity, frequency, and temperature to fulfil the daily tasks on the job site. For quick and easy testing of electrical lines, the G9204 is also equipped with non-contact voltage detection and is tested for safe use in CAT II 600V/CAT III 600V environments. With an ergonomic design and large backlight LCD display, the G9204 is every technician's go-to tool for their electrical testing requirements.



- Multi function for AC-DC Voltage, AC current, Resistance, Diode, Continuity, Frequency, Temperature measurements
- 1000A full range overload protection for additional safety during measurement
- CAT II 600V / CAT III 300V safety rating with double insulation
- Includes Gazelle branded carrying case

Standard Accessories

- Operating Manual
- Test Lead
- Temperature Probe
- Carrying Case

Specifications	Range	Best Accuracy
AC Current (A)	400A/1000A	±(1.5%+5)
AC Voltage (V)	4V/40V/400V/600V	±(1.2%+5)
DC Voltage (V)	400mV/4V/40V/400V/600V	±(0.8%+1)
Resistance (Ω)	400Ω/4kΩ/40kΩ/400kΩ/4MΩ/40MΩ	±(1%+2)
Frequency (Hz)	10Hz~10MHz	±(0.1%+3)
Temperature (°C)	-40°C~1000°C	±(2%+8)
Features		
Jaw Capacity	40mm	
Diode	√	
Continuity Buzzer	√	
Low Battery Indication	√	
LCD Backlight	√	
Input Impedance for DCV	Around 10MΩ	
Battery	9V Battery (6F22)	

True RMS AC/DC Clamp Meter, 600A

G9200 Series - G9205

The GAZELLE G9205 True RMS Digital Clamp Meter is a portable, auto-ranging AC/DC clamp meter capable of measuring AC/DC current up to 600A and AC/DC voltage up to 600V. The G9205 also supports diode and continuity tests, as well as non-contact voltage detection (with an audio/ visual alert), and live/neutral wire detection.



- High voltage (600V) frequency measurement
- NCV multi-segment display and audio/visual alarm
- 600V protection across all range in current and voltage range measurement
- Accuracy guarantee range 1%~100%

Standard Accessories

- Batteries
- Test Leads
- Thermocouple

Specifications	Range	Best Accuracy
AC Current (A)	0.06~600A	±(2%+5)
DC current (A)	0.06~600A	±(2%+5)
AC voltage (V)	600V	±(0.8%+5)
AC voltage frequency (Hz)	10Hz~60kHz	±(0.5%+2)
DC voltage (V)	600V	±(0.5%+2)
Resistance (Ω)	60MΩ	±(0.8%+2)
Capacitance (F)	60mF	±(4%+5)
Temperature (°C)	-40°C~1000°C	±(1.5%+5)
Frequency (Hz)	10Hz~10MHz	±(0.1%+4)
Features		
Display count		6000
Auto range		√
Jaw opening		28mm
True RMS		√
NCV		√
Continuity test		√
Diode		√
MAX/MIN		√
Relative Mode		√
Zero Mode		√
Data Hold		√
Low Battery Indication		√
Auto Power Off		√

Non Contact Voltage Detector, 1000V

G9300 Series - G9301-II

The GAZELLE G9301-II Non-Contact Voltage Detector is easy to use just by just touching the tip to the cable, electrical outlet, or supply cord. When the tip red light is ON and the unit beeps, a voltage is present. Best for electricians, maintenance technicians, safety officers, and anyone who needs to quickly check if the circuits are energised in the workplace or at home.



- Loud audible sound alarm and red-light alert upon live cable detection
- CAT IV 1000V for added protection
- Wide sensitivity range with detection from 90 V to 1000 V AC

Standard Accessories

- Operating Manual
- Batteries

Specifications	Range
AC Voltage (Low)	24V - 1000V
AC Voltage (High)	90V - 1000V
Frequency (Hz)	50/60Hz
Power	1.5V batteries (R03) × 2
Operating Mode	Automatic Induction
Spotlight Flashlight	White spotlight
Audible (buzzer) and visual (LED) indication	√
Auto power off	About 5 minutes
Low battery indication	√



Scan for video

Socket Tester

G9300 Series - G9302

The GAZELLE G9302 Socket Tester is an easy and quick way to verify a 3-pin plug's wiring. Simply plug the G9302 directly into the socket and see the connection result. The LED lights on the front of the socket tester will light up in various combinations to indicate the condition of the connection. Capable to diagnose results such as: Correct, Missing Earth, Live Earth Reverse, Live Neutral Reverse, and Missing Neutral.



- Easy to use! Simply plug into the live socket and see the connection result
- Quickly diagnose for Correct, Missing Earth, Live Earth Reverse, Live Neutral Reverse, Missing Neutral
- Double insulated safety rated and CE certified product

Standard Accessories

- Operating Manual

Specifications	Range
Rated Voltage	250V AC
Rated Current	13A
Operating Voltage	230V AC/50Hz
Operating Current	<18mA
Working Frequency	50~60Hz
Warning Sign	√
Double Insulation	√
LED Indications	√



Scan for video

Phase Sequence & Motor Rotation Indicator

G9300 Series - G9303

The GAZELLE G9303 Phase Sequence and Motor Rotation Indicator provides motor rotation and rotary field indication using contactless detection, ideal for use in a running motor. Designed for industrial and commercial applications, the G9303 also lets the user measure three-phase rotations using test leads supplied for direct connection testing. The included test probes have a variable clamping range for safe direct contact testing.



- CAT III 600V safety rating with double insulation
- Includes three-test leads with alligator clip for direct to cable phase sequence testing
- Easy to use contact-less detection ideal for use in running motor
- Can give a quick identification of Right rotation or Left rotation
- Double insulated safety rated and CE certified product

Standard Accessories

- Operating Manual
- Test Leads - 3pcs
- Alligator Clips - 3pcs
- Carrying Bag
- 9V Battery

Specifications	Range
AC Voltage (V)	90V~600V
Frequency (Hz)	15Hz~400Hz
Working Current (A)	<3mA
Features	
Phase Sequence Indication	LED
Missing Phase Indication	LED
Motor Rotation Indication	LED
General Characteristics	
Power	9V Battery



Scan for video

Insulation Resistance Tester, 1kV

G9300 Series - G9304

The GAZELLE G9304 Insulation Tester can be used for both troubleshooting and preventive maintenance activities. Tested for safe use in CATIII 600V environment and has a selectable step voltage of 250V, 500V and 1000V. Features auto calculation of PI and DAR measurement. So whether you work on cables, motors or switch gears, the G9304 Insulation Tester is ideally suited to help you with your tasks to improve QEPS (Quality, Efficiency, Productivity, Safety).



- Insulation Resistance with AC voltage and low resistance measurement testing
- With a 3-selection of voltage testing of 250V, 500V and 1000V
- PI and DAR test measurement
- CAT III 600V safety rating with double insulation
- One press start and stop button with light indicator during testing.
- Includes GAZELLE carrying case



Standard Accessories

- Operating Manual
- Test Leads - 3pcs
- Carrying Bag
- 1.5V AA - 6pcs

Specifications	Range	Best Accuracy
Insulation Resistance (Ω)	Test Voltage - 250V/500V/1000V	0%~10%
	250V - 0.00M Ω ~5.5G Ω	$\pm(3\%+5)$
	500V - 0.00M Ω ~5.5G Ω	$\pm(3\%+5)$
	1000V - 0.00M Ω ~5.5G Ω	$\pm(3\%+5)$
Low Resistance (Ω)	0.01 Ω ~200 Ω (about 5.0V/>200mA)	$\pm(2\%+3)$
AC Voltage (V)	30V~600V	$\pm(2\%+3)$
Features		
DAR		60s/15s and 60s/30s
PI		√
LCD Backlight		√
Alarm Light Display		√
Auto Discharge		√
Test Voltage Vice Display		√
Power		1.5V Batteries AA × 6

Earth Resistance Tester, 4000Ω

G9300 Series - G9305

The GAZELLE G9305 Earth Resistance Tester, 4000Ω is essential to maintaining safety, protecting lives, as well as to prevent damage to equipment. The G9305 can perform precise 3-wire and simple 2-wire earth resistance measurements for power and electrical systems, lightning protection equipment, and ground system of all electrical equipment. The G9305 has a large, easy-to-read display, heavy-duty earthing rods, earth voltage measurement capabilities and an internal memory that can save up to 20-group test results.



- Two-pole ground resistance testing
- Large and easy-to-read display
- Includes heavy duty earthing rods and carrying case.
- Internal memory can save up to 20-group test results



Standard Accessories

- Operating Manual
- Green test lead (5m)
- Yellow test lead (10m)
- Red test lead (20m)
- Auxiliary earth stakes - 2pcs
- Simple test leads with alligator clips
- 1.5V Alkaline Battery (AA) - 6pcs
- Carrying bag

Specifications	Range
Earth Resistance (Ω)	0~4000Ω / ±(2%+3)
AC Earth Voltage (V)	0~400V / ±(1%+6)
Frequency	50Hz/60Hz
Features	
Manual Range	√
Auto Power Off	About 10 minutes
Low Battery Indication	√
Data Hold	√
Data Storage	20 groups
LCD Backlight	√
Simple 2-Wire Testing	√
Precision 3-Wire Testing	√
Power	1.5V Batteries AA × 6



Scan for video

RCD/ELCB Tester

G9300 Series - G9306

The GAZELLE G9306 RCB-ELCB Tester is designed to perform quick checks of your electrical panels. Whether you conducting the testing & commissioning of a newly installed electrical panel, a routine check or preventive maintenance of an existing panel, the G9306 RCD/ELCB Tester is the perfect instrument for your testing requirements.



- Lock measurement
- Lead sequence check with 3 LED indication lights
- Phase angle selection (0° and 180°) to detect the fastest trigger time
- AUTO RAMP measurement, trip current and real-time display

Standard Accessories

- Operating Manual
- Test Lead
- Carrying Case

Specifications	Range Select		Range	Best Accuracy
RCD/ELCB Measurement	X 1/2	10mA/20mA/30mA/ 100mA/300mA/500mA	1000ms -	-
	X 1	10mA/20mA/30mA/ 100mA/300mA/ 500mA	1000ms 300ms	-
	X 5	10mA/20mA/30mA	1000ms	-
	AUTO RAMP	10mA/20mA/30mA/ 100mA/300mA/500mA	300ms	-
	Trip Current Accuracy	-	-	±10
	Trip Time Accuracy	-	-	±(0.6%+4)
	Trip Time Resolution	1ms	-	-
	Operational Voltage (Freq.)	195V~253V (50Hz)	-	-

Multifunction Electrical Tester

G9300 Series - G9307

The GAZELLE G9307 Multifunction Tester puts the power of insulation and RCD testing capability in a single tool. The G9307 gives you the reliability and confidence you need for day-in, day-out installation testing. It is capable of insulation testing as well as has the capability of carrying out RCD/ELCB testing that can be used both for troubleshooting and preventive maintenance activities. The combined capabilities make the G9307 an ideal tool for all electrical contractors and facility management electricians.



- Over range indication, test lead connection alarm
- TEST button for fast capture of measurement values
- Large, backlit display for easy visibility in low-lit work environments
- Data hold
- Auto power off/battery check
- Earth voltage measurement



Standard Accessories

- Operating Manual
- Test Lead
- Carrying Case

Specifications		Range	Best Accuracy
Insulation Resistance (Ω)	Test Voltage	250V/500V/1000V	$\pm 10\%$
	250V	0.05M Ω ~200M Ω	$\pm(5\%+5)$
	500V	0.05M Ω ~300M Ω	$\pm(5\%+5)$
	1000V	0.05M Ω -500M Ω	$\pm(5\%+5)$
RCD	Operational Voltage (Freq.)	220V (45Hz--65Hz)	$\pm 10\%$
	Test Current	10mA/30mA/100mA/300mA	0~20%
	Trip Time	0ms~2000ms, 1 Δ n Genital (10mA) 0ms~500ms, 1 Δ n Genital (30mA) 0ms~300ms, 1 Δ n Genital (100mA, 300mA)	$\pm(5\%+2)$
Low Resistance Continuity	Range	0.00 Ω ~2000 Ω	$\pm(2\%+5)$
	Test Voltage	Around 5.0V	-
	Test Current	>200mA (R<2 Ω)	-
Voltage Measurement (V)	DC Voltage	0~440V	$\pm(5\%+2)$
	AC Voltage	0~440V	
Frequency (For reference only)			



Scan for video

Portable Appliance Tester

G9300 Series - G9308

The GAZELLE G9308 Portable Appliance Tester is used by professionals at all levels of expertise. With its easy-to-use interface, ability to test all appliances, and portable, battery-powered design, this PAT Tester is crucial for maintaining electrical safety in any workplace. The tester features a one-touch solution with auto-test capabilities, enabling you to work faster without compromising on your safety.



- Easy-to-use PAT tester which does all the tests you need with minimal effort
- Ideal for use by those new to PAT testing, or those with a smaller amount of appliances to test with up to 1000 test battery life
- Insulation test at 250V and 500V
- Earth continuity test (IT equipment safe)
- Built-in mains socket connector
- Simple interface - three buttons on the front clearly labelled for each appliance type

Standard Accessories

- Batteries
- Hard Carrying Case
- Alligator Clip
- Test Lead
- Instruction Manual
- IEC Lead

Specifications	Range	Best Accuracy	Parameter
Insulation Resistance Test	0.20MΩ~19.99MΩ	±5%+2	Output Voltage 250V / 500V
			Output Current (R=500KΩ): > 1mA (R=1KΩ): < 2mA
			Short-circuit Current < 3mA
Ground Resistance	Class I PASS Value 0.2Ω	±5%+2	Measuring Current > 200mA (R<2Ω)
	IEC Lead PASS Value 0.2Ω	±5%+2	Measuring Voltage 5V DC
Leakage Test	0.10~10.5mA	±5%+2	Measuring Voltage 40V rms Test Frequency 59Hz AC
IEC Lead Test + 30m Long Lead Test	Correct Wiring	√ GOOD	
	Open Circuit, Short Circuit, Reverse Polarity	X FAIL	
Power Socket Test	Normal	Prompt “LN √, LE √, NE √”	AC220V ±10% Input
		Earth Fault	Prompt “LN √, LE x, NE x”
	Neutral Line Fault	Prompt “LN x, LE √, NE x”	AC220V ±10% Input
Features			
Mode			√
Low Battery Indication			√

Ordering Information



G9308-KIT **Portable Appliance Tester Kit**

G9308 **Portable Appliance Tester**

- G9308 PAT tester
- Test Lead
- Alligator Clip
- IEC Lead
- Hard carrying case
- Batteries
- Instruction Manual

G9308-KIT **Portable Appliance Tester Kit**

- G9308 PAT tester
- G9301-II Voltage Detector
- G9302 Socket Tester
- G80363 VDE Screwdriver 13 pcs. set
- G9904 Pass/Failed Labels
- USB with Gazelle PAT Software

Multi-functional Electrical Measuring Instrument

G9300 Series - G9309

The GAZELLE G9309 Multifunction Installation Tester is an easy-to-use and intuitive instrument used for regular installation and maintenance testing. Designed with a combination of large-scale integrated analog & digital circuits and micro-processor chip, the G9309 measures RCD, line/loop impedance, continuity, insulation resistance, DC and AC voltage, and phase sequence. It's an ideal tool for testing, inspection and maintenance which features versatile functionality, higher accuracy, stable performance and ease of use that saves time and gives you more confidence in your results.



Standard Accessories

- Batteries
- Test Leads
- Hard Carrying Case
- Instruction Manual

- 9999-count LCD display with analogue bar; auto power off
- 250V~1000V DC insulation resistance test
- 200mA earth-resistance continuity test
- Measures RCD trip current and trip time in parallel (RCD type AC and A)
- Measures RCD switching time and tripping level (ramp test)
- Measures RCD variable current
- Loop impedance/Prospective Fault Current (PFC)/Prospective Short Current (PSC) test
- Lock test
- Data storage with one key
- 0°/180° phase angle option to detect the fastest trigger time
- Includes a phase sequence indicator
- AC/DC voltage auto check and test
- Features large display with white backlight, clear symbols, and wide viewing angle for easy and safe readings
- Rotary dial knob clearly indicates which function is selected, all in one spot with no complex multi-level menus.
- Performs fast voltage measurement between L-N, L-PE, and N-PE using the mains cord. No need to change measurement connections
- Comes with hard carrying case, test leads and batteries

Specifications		Range	Best Accuracy
Insulation Resistance (Ω)	Output voltage	250V/500V/1000V	$\pm 10\%$
	250V	0.05M Ω ~250M Ω	$\pm(5\%+5)$
	500V	0.05M Ω ~500M Ω	
	1000V	0.05M Ω ~1000M Ω	
Continuity test	Short-circuit current	<1.8mA	<2mA
	Range	0.01 Ω ~200 Ω	$\pm(2\%+5)$
	Test current	0.00~2 Ω : >200mA	\checkmark
Line impedance (Ω)	Operating Voltage (L-N)	Voltage: 195V~440V, Frequency: 45Hz~65Hz	
	Test Current & Time	20A/20ms	
	Measuring Scope	0.05 Ω ~2000 Ω	
	Measuring Ranges	0.05 Ω ~1.99 Ω	
		2.0 Ω ~19.9 Ω	
		20 Ω ~2000 Ω	
	Accuracy	$\pm(5\%+5)$	
Resolution	Minimum 0.01 Ω		
Prospective Short Current	0KA~26KA		
Loop impedance (Ω)	Operating Voltage (L-E)	Voltage: 220V $\pm 10\%$, Frequency: 45Hz~65Hz	
	Test Current & Time	20A/20ms	
	Measuring Scope	0.05 Ω ~2000 Ω	
	Measuring Ranges	0.05 Ω ~1.99 Ω	
		2.0 Ω ~19.9 Ω	
		20 Ω ~2000 Ω	
	Accuracy	$\pm(5\%+5)$	
Resolution	Minimum 0.01 Ω		
Prospective Fault Current	0KA~26KA		
Non-trip loop impedance (Ω)	Operating Voltage (L-E)	Voltage: 220V $\pm 10\%$, Frequency: 45Hz~65Hz	
	Test Current	20A	
	Display Range	0.01 Ω ~2000 Ω	
	Measuring Scope	1.00 Ω ~2000 Ω	
	Measuring Ranges	1.00 Ω ~1.99 Ω	
		2.0 Ω ~19.9 Ω	
		20 Ω ~2000 Ω	
Accuracy	$\pm 5\% \pm 12d$ + Noise Margin (1.00~1.99) $\pm 5\% \pm 5d$ (2.0~19.9)		
Resolution	Minimum 0.01 Ω		
Prospective Fault Current	0KA~26KA		
RCD test	Operating voltage (Frequency)	195V~253V (45Hz~65Hz)	
	Test current	10mA/30mA/100mA/300mA/500mA	
	Trip time	$\times 1/2$ *I Δ n Range: 0ms~2000ms	
		$\times 1$ *I Δ n Range: 0ms~500ms (Select count down)	
		$\times 1$ *I Δ n Range: 0ms~300ms	
		$\times 2$ *I Δ n Range: 0ms~150ms	
$\times 5$ *I Δ n Range: 0ms~40ms			
$\times 2$ *I Δ n Range: 0ms~200ms (Select count down)			

Specifications		Range	Best Accuracy
Phase sequence test	Operating voltage (Frequency)	100V~440V (45Hz~65Hz)	√
	Display	Phase sequence: L1→L2→L3, forward rotation; L1→L3→L2 reverse rotation	√
Ramp RCD test	Test current	10mA/30mA/100mA/300mA/500mA	±10%
AC voltage (V)	Range	0V~440V	±(5%+2)
	Frequency response	45Hz~65Hz	√
	Resolution	1V	√
Features			
Display count			9999
Auto power off			√
Low battery indication			√
Data Storage			√
LCD backlight			√
Auto half-wave test			√
RCD count down test	30s		√
RCD half-wave test			√
Phase conversion (RCD)	0° and 180°		√
General Characteristics			
Power		1.5V battery × 8	
LCD size		125mm × 37mm	
Product color		Blue and grey	
Product net weight		1000g	
Product size		210mm × 175mm × 90 mm	
Standard accessories		Battery, test leads (red×1, green×1, black×1), special power test lead, remote-control test lead	

Insulation Resistance Tester, 2.5kV

G9300 Series - G9310

The GAZELLE G9310 Insulation Resistance Tester, 2.5kV plays an important role in testing insulation resistance during maintenance and troubleshooting of large transformers, generators, high-voltage motors, electrical wiring work, plant equipment management, and more. It can swiftly identify system problems that could potentially cause safety hazards and production downtime. The instruments are portable and user-friendly with enhanced functionality. The G9310 can also measure PI, DAR and other important specifications. Measured data can then be analysed through PC software.



- Large 9999 display with 30-segment analog bar graph
- PI/DAR measurements & Continuous measurement mode
- Comparison, upper and lower limit functions with 18-group data storage
- Auto power off, backlight, and low battery & over range indications
- Auto current discharge and high-voltage output alarm
- Power adapter, USB interface and PC software
- Time measurement mode, auto measure within 15 minutes

Standard Accessories

- 2 pcs. 1 Plug Test Lead to 1 Alligator Clip
- 1 pc. 2 Plugs Test Lead to 1 Alligator Clip
- Batteries
- USB Cable
- PC Software CD
- Power Adaptor

Specifications		Range	Best Accuracy
Insulation Resistance	Test Voltages	100V~1000V	0%~20
		500V~2500V	
	100V	0.1MΩ~500MΩ	±(3%+5)
	250V	0.5MΩ~2GΩ	
	500V	1MΩ~4GΩ	±(3%+5)
		0.5MΩ~5GΩ	
	1000V	0.5MΩ~20GΩ	±(3%+5)
		2MΩ~10GΩ	
	1500V	1MΩ~40GΩ	±(3%+5)
		5MΩ~20GΩ	
2500V	2.5MΩ~100GΩ	±(3%+5)	
	10MΩ~100GΩ		
DC Voltage (V)	1000V		±(2%+5)
	600V		
AC Voltage (V)	750V		±(2%+5)
	600V		
Short-circuit current			<1.8mA
Low Resistance (Ω)	0.1Ω~999.9Ω		

Features		
Auto range/Auto Power Off		√
Test voltage secondary display		
Low Battery Indication		√
Data Storage		18
Comparison Measurement		√
Polarization Index (PI)		√
Dielectric absorption ratio (DAR)		√
USB Interface		√
Analog bar graph		30
LCD Backlight		√
Over-range Warning		√
High Voltage Indication		√
Timing Measurement	Around 30 minutes	
	Around 15 minutes	√

Insulation Resistance Tester, 5kV

G9300 Series - G9311

The GAZELLE G9311 Insulation Resistance Tester, 5kV plays an important role in testing insulation resistance during maintenance and troubleshooting of large transformers, generators, high-voltage motors, electrical wiring work, plant equipment management, and more. It can swiftly identify system problems that could potentially cause safety hazards and production downtime. The instruments are portable and user-friendly with enhanced functionality. The G9311 can also measure PI, DAR and other important specifications. Measured data can then be analysed through PC software.



- Large 9999 display with 30-segment analog bar graph
- PI/DAR measurements & Continuous measurement mode
- Comparison, upper and lower limit functions with 18-group data storage
- Auto power off, backlight, and low battery & over range indications
- Auto current discharge and high-voltage output alarm
- Power adapter, USB interface and PC software
- Time measurement mode, auto measure within 15 minutes

Standard Accessories

- 2 pcs. 1 Plug Test Lead to 1 Alligator Clip
- 1 pc. 2 Plugs Test Lead to 1 Alligator Clip
- Batteries
- USB Cable
- PC Software CD
- Power Adaptor

Specifications		Range	Best Accuracy
Insulation Resistance	Test Voltages	100V~1000V	0%~20
		500V~2500V	
		500V~5000V	
	100V	0.1MΩ~500MΩ	±(3%+5)
	250V	0.5MΩ~2GΩ	
	500V	1MΩ~4GΩ	±(3%+5)
		0.5MΩ~5GΩ	
	1000V	0.5MΩ~20GΩ	±(3%+5)
		2MΩ~10GΩ	
	1500V	1MΩ~40GΩ	±(3%+5)
2500V	5MΩ~20GΩ		
	5000V	2.5MΩ~100GΩ	±(3%+5)
10MΩ~100GΩ			
DC Voltage (V)	600V	5MΩ~1000GΩ	±(3%+5)
		±(2%+3)	
AC Voltage (V)	600V		±(2%+3)
Short-circuit current			>3mA

Features		
Auto range/Auto Power Off		√
Test voltage secondary display		√
Low Battery Indication		√
Data Storage		18
Comparison Measurement		√
Polarization Index (PI)		√
Dielectric absorption ratio (DAR)		√
USB Interface		√
Analog bar graph		30
LCD Backlight		√
Over-range Warning		√
High Voltage Indication		√
Timing Measurement	Around 30 minutes	
	Around 15 minutes	√

Insulation Resistance Tester, 12kV

G9300 Series - G9312

The GAZELLE G9312 Insulation Resistance Tester, 12kV is a digital high voltage insulation resistance tester with 6 ranges: 500V, 1000V, 2500V, 5000V, 10000V and 12000V. The G9312 plays an important role in testing insulation resistance during maintenance and troubleshooting of large transformers, generators, high-voltage motors, electrical wiring work, plant equipment management, and more. It can swiftly identify system problems that could potentially cause safety hazards and production downtime. The instruments are portable and user-friendly with enhanced functionality. The test data can be saved in the tester memory and transferred to a PC via the dedicated USB cable, or be transferred to a PC in real-time.



- AC/DC voltage
- USB data transfer
- 9999 Max display, low battery indication & LCD backlight
- Data storage & Polarization Index
- Over-range alarm
- Comparative measurement & measurement time selection

Standard Accessories

- User Manual
- Test Leads
- USB Cable
- Power Adaptor
- 1.5B Batteries

Specifications		Range	Best Accuracy
Insulation Resistance	500V	0.50MΩ~4.99GΩ	±(5%+5)
		5.00GΩ~49.9GΩ	±(10%+10)
		50.0GΩ~500GΩ	for reference only
	1000V	1.00MΩ~9.99GΩ	±(5%+5)
		10.0GΩ~99.9GΩ	±(15%+10)
		100GΩ~1000GΩ	for reference only
	2500V	2.50MΩ~24.9GΩ	±(5%+5)
		25.0GΩ~249GΩ	±(15%+10)
		250GΩ~2.5TΩ	for reference only
	5000V	5.00MΩ~49.9GΩ	±(5%+5)
		50GΩ~499GΩ	±(15%+20)
		500GΩ~5.0TΩ	for reference only
	10000V	10.0MΩ~99.9GΩ	±(10%+10)
		100GΩ~999GΩ	±(20%+20)
		1000GΩ~10TΩ	for reference only
12000V	12.0MΩ~99.9GΩ	±(10%+10)	
	100GΩ~999GΩ	±(20%+20)	
	1000GΩ~10TΩ	for reference only	

Specifications	Range	Best Accuracy
Output Voltage	500V	0~+10%
	1000V	0~+10%
	2500V	0~+10%
	5000V	0~+10%
	10000V	-5~+10%
	12000V	-5~+10%
Load Current	500V (R=500kΩ) 1mA	0%~+20%
	1000V (R=1MΩ) 1mA	0%~+20%
	2500V (R=2.5MkΩ) 1mA	0%~+20%
	5000V (R=5MΩ) 1mA	0%~+20%
	10000V (R=10MΩ) 0.15~1.2mA	0%~+20%
	12000V (R=12MΩ) 0.15~1.2mA	0%~+20%
DC Voltage Measurement	30V~1000V	±(3%+5)
AC Voltage Measurement	30V~750V (50~60Hz)	±(3%+5)

Features

PC Software For Data Analysis	√
Backlight Function	√
Data Storage	999 sets of data
Dielectric Absorption Ratio (DAR)	0.00~999
Polarization Index (PI)	0.00~999
Power	1.5V Alkaline Batteries (LR14) x 10, Power Adapter
Display	71mm x 34mm
Product Color	Red and Grey
Product Net Weight	6.6 kg
Product Size	410 mm x 342 mm x 204 mm
Standard Quantity Per Carton	1 pc.
Standard Carton Measurement	510 mm x 320 mm x 420 mm
Standard Carton Gross Weight	10.2 kg



Scan for video

Temperature Humidity Meter

G9400 Series - G9401

The GAZELLE G9401 Temperature Humidity Meter features a large triple display of indoor measurements of relative humidity, temperature, and external secondary temperature with maximum and minimum readings. The remote temperature probe extends for 1 meter to measure behind walls, inside refrigerators or to soak into water. Ideal for use in humid areas where mould can become a problem. The meter has a built-in stand for sitting on a desk but can also be mounted to a wall with an additional clock and alarm clock function.



- Sampling time: 10s
- Display of temperature, humidity, time, and comfort level together
- Dual temperature measurement
- Clock function: 12/24 hour modes
- Alarm clock: Rings up to 60s
- Comfort level: comfortable, wet, dry
- Optional hanging hole and tripod for wall or table mount

Standard Accessories

- Operating Manual
- 1.5V AAA Battery

Specifications		Range
Temperature	Range	-10~50°C (14~122°F)
	Resolution	0.1°C (0.1°F)
	Accuracy	±1°C (±1.8°F)
External temperature probe	Range	-10~50°C (14~122°F)
	Resolution	0.1°C (0.1°F)
	Accuracy	±1°C (±1.8°F)
Humidity	Range	10~99%RH
	Resolution	1%RH
	Accuracy	±5%RH
Features		
Sampling frequency		10s
Alarm Clock		√
Battery		1*AAA
Certification		CE

Mini Contact Thermometer

G9400 Series - G9402

The GAZELLE G9402 Mini Contact Thermometer is a dual-input digital thermometer that delivers a fast response. Designed to measure two contact temperature inputs simultaneously, whether measuring motors, insulation, pipes, liquids, and wires with industrial standard J, K-type thermocouple temperature sensors. The user friendly-front panel and large, backlit display make it easy to view results from both channels.



- 1m drop proof
- Maximum/minimum/average
- Big LCD display with bright white backlight for a clear view of measurement
- K/J thermocouple probe selection
- Difference measurement: T1~T2
- CE Certified

Standard Accessories

- Operating Manual
- Temperature Probe
- 1.5V AAA - 3pcs

Specifications	Range	Best Accuracy
Temperature measurement (K)	-50~1300°C	±(0.5%+1)
Temperature measurement (J)	-50~1200°C	±(0.5%+1)
Features		
Difference measurement (T1-T2)		√
Unit conversion (°C/°F)		√
Max/Min/Avg		√
Function selection (K/J)		√
Backlight		√
Working temperature		0°C~40°C
Working humidity (relative)		≤80%RH
1m drop test		√
Power		3 x AAA



Scan for video

Mini Contactless IR Thermometer

G9400 Series - G9403

Measure temperature safely and accurately from a distance with GAZELLE infrared thermometers. The GAZELLE G9403 Mini IR Thermometer is a user-friendly, compact thermometer featuring a 6:1 distance to spot ratio and a precise single laser for accurate and repeatable measurements. With its rugged build enough to take a one-metre drop, it is best used to perform non-contact temperature measurements on transformers, motors, pumps, panels, breakers, compressors, ducts, and vents. The single laser helps the user pinpoint the target for more accurate readings, making it easier to measure temperatures in hard-to-reach areas.



- Single-laser targeting
- Big LCD display with bright white backlight for a clear view of measurement
- 1m drop tested
- Max/Min/Avg modes
- Lock measurement
- Data hold; auto power off
- °C/°F selections

Standard Accessories

- Operating Manual
- 1.5V AAA - 3pcs

Specifications	Range	Best Accuracy
Measurement Range (°C)	-35~300°C (-31°F~572°F)	≥0°C: ±2.0°C or ±2% of reading, whichever is greater <0°C: ±(2.0°C+0.1°C/°C)
Temperature Coefficient	0.1°C/°C (0.1°F/°F) or ±0.1% of reading, take the higher value	
Repeatability	±1.0°C (2.0°F) or ±1.0% of reading, Whichever is higher	
Features		
Optical resolution		6:1
Emissivity		0.95
Response time		250ms
Spectral response		8um ~ 14um
Data hold		√
Unit conversion (□/□)		√
Max/Min/Avg		√
Lock measurement		√
Backlight		√
Laser		√
Operating temperature		0°C~ 50°C (32°F~ 104°F)
Storage temperature		-20°C~ 60°C (-4°F~ 140°F)
Relative humidity		<90%RH (non-condensing)
Drop test		1m
Power		3x AAA Batteries

Mini Infrared Thermometer

G9400 Series - G9403-II

Measure temperature safely and accurately from a distance with GAZELLE infrared thermometers. The GAZELLE G9403-II Mini Infrared Thermometer is a user-friendly, compact thermometer featuring a 12:1 distance to spot ratio and precise single laser for accurate and repeatable measurements. With its rugged build enough to take a one-metre drop, it is best used to perform non-contact temperature measurements on transformers, motors, pumps, panels, breakers, compressors, ducts, and vents. The single laser helps the user pinpoint the target for more accurate readings, making it easier to measure temperatures in hard-to-reach areas.



- Single-laser targeting
- Big LCD display with bright white backlight for a clear view of measurement
- 1m drop tested
- Max/Min/Avg modes
- Lock measurement
- Data hold; auto power off
- °C/°F selections

Standard Accessories

- Operating Manual
- 1.5V AAA - 3pcs

Specifications	Range
Certifications	CE, UKCA
Temperature range	-50°C~500°C
Laser type	circle
Accuracy	±2°C or ±2%
Resolution	0.1°C
D:S ratio	12:1
Response time	≤250ms
Emissivity	0.10~1.00 Adjustable
Laser class	Class 2
Laser power	<1mW
Laser wavelength	630nm~670nm
Spectral response	8µm~14µm
Features	
Display type	EBTN-LCD
Unit selection	°C/°F
Laser on/off	√
Data hold	√
Auto power off	√
Low battery indication	√
MAX/MIN/AVG/DIF mode	√
High/low temperature alarm (audible)	√
Drop test	1m



Scan for video

Contactless IR Thermometer

G9400 Series - G9404

Measure temperature safely and accurately from a distance with GAZELLE infrared thermometers. The GAZELLE G9404 Contactless IR Thermometer measures the temperature of surfaces via infrared beam from a distance. The contactless infrared thermometer has a visible laser beam for precise, contactless pointing and quick temperature measurement from a safe distance of hot moving objects.



Standard Accessories

- Operating Manual
- 9V Battery



- Accurate infrared thermometer for professionals working in tough environments
- IP65-rated, rugged tool that passes 3-meter drop tests
- 10:1 distance-to-spot ratio and precise single laser targeting for accurate and repeatable measurements
- Has a high and low alarm with blue and red light indicators
- User friendly and includes a soft carrying case
- Best use to perform non-contact temperature measurements on transformers, motors, pumps, panels, breakers, compressors, ducts, and vents

Specifications	Range
Temperature Range	-35°C~450°C
Measurement Accuracy	>0°C:±1.8°C or ±1.8% which is greater,<0°C: ±1.8°C+0.1°C/°C) > 32°C ± 3.6°F or ±1.8% which is greater, <32°F: ±(3.6°F+0.1°F/°F)
Repeated accuracy	1.0°C(2.0°F) or 1.0% of reading, whichever is greater
Display resolution	0.1°C/0.1°F
D:S (Distance to Spot Size)	10:1 / 250ms (95% of reading) Response Time
Emissivity (adjustable, step length: 0.01)	0.95
Laser count	Single laser / Type 2
Features	
High and Low temperature alarm	√
LCD backlight	√
Protection grade	IP65
Drop test	3 meters
Tripod mounting holes	√
Power supply	9V battery



Scan for video

Mini Temperature & Humidity Meter w/ Bluetooth

G9400 Series - G9405-Log

Humidity and temperature are the two crucial factors monitored when assessing indoor air quality to maintain optimal comfort levels. The GAZELLE G9405-Log Mini Temperature & Humidity Meter is the perfect tool for users to quickly and conveniently take readings to scan and detect problem areas. With its lightweight and rugged, ergonomic design, the G9405-Log is ideal for HVAC-service contractors and utilities and facilities management technicians.



- Temperature measurement range: -10~60°C/14~140°F
- Humidity measurement range: 0~100%RH
- Light weight, ergonomic design, user-friendly interface
- MAX/MIN modes, auto power off, low battery indication

Standard Accessories

- Operating Manual
- 1.5V AAA - 3pcs

Specifications	Range	Resolution	Best Accuracy
Humidity	0~99%RH	0.1%RH	±5~RH (0~99%RH)
	-10~60°C	0.1°C	±1.0°C
	14~140°F	0.2°F	±2.0°F
Features			
Sampling Rate			0.5s
Unit Conversion			°C/°F
LCD Backlight			Yes
Battery			AAA 1.5V*3 batteries
Working Environment			Temperature : 0~40°C Humidity: ≤80%RH
Storage Environment			Temperature: 20~60°C below Humidity: ≤75%RH
MAX/MIN			MAX/MIN
Data Hold			HOLD



Scan for video

Mini Sound Level Meter w/ Bluetooth

G9400 Series - G9406-Log

The GAZELLE G9406-Log Mini Sound Level Meter is designed to measure outdoor and indoor noise levels at a measuring accuracy of 1.5 dB. Widely used in noise detection, quality control, health & safety, and environmental studies, the G9406-Log is compact and portable, making it ideal for mobile measurements of sound. Noise generated in various environments such as workplaces, machine controls, and construction sites can be easily measured and displayed with the backlit digital display, offering users the most convenient measurement readings of sound levels.



- MAX/MIN modes
- Auto power off (cancelable)
- Data hold, LCD backlight
- Simulated analog bar
- A (ear)/C (machine) weighting modes
- Manual/auto range selectable
- Fast/slow response rate (fast: 125ms, slow: 1s)
- Powered by batteries or external power source

Standard Accessories

- Operating Manual
- 1.5V AAA - 3pcs

Specifications	Range	Best Accuracy
Noise (A Weighting)	30~130dB (0.1dB Res)	±5~RH (0~99%RH)
Sampling Rate	FAST	±1.0°C
	SLOW	±2.0°F
MAX/MIN		MAX/MIN
Data Hold	0.5s	HOLD
LCD Backlight	°C/°F	Yes
Battery	Yes	AAA 1.5V*3 batteries
Working Environment	Temperature	0~40°C
	Humidity	≤80%RH
Storage Environment	Temperature	-20~60°C
	Humidity	≤75%RH



Scan for video

Mini Anemometer w/ Bluetooth

G9400 Series - G9407-Log

The GAZELLE G9407-Log Mini Anemometer is widely used in wind speed measurements for HVAC quality control, health and safety, environmental, petrochemical, navigation, fan manufacturing, exhaust ventilation, sports, and others. This lightweight device is equipped with the latest magnetic sensing technology which can directly display the airflow speed on the LCD display. It is a compact and pocket-sized anemometer which is easy to use and easy to store.



- Data hold, LCD backlight
- °C/°F selectable
- Auto power off (cancelable)
- Auto record function with 0.5~255s interval
- Wearproof fan shaft for improved accuracy and reliability
- Wind speed modes: MAX, MIN, Real-time
- Wind count modes: MAX, 2/3 MAX, MIN, AVG, real-time
- 7 selectable units: m/s, km/h, ft/min, MPH, KNOTS

Standard Accessories

- Operating Manual
- 1.5V AAA - 3pcs

Specifications	Range	Resolution	Best Accuracy
Wind Speed	0~30m/s	0.1m/s	±5%rdg+0.5
Temperature	-10~50°C	0.1°C	±2°C
	14~122°F	0.2°F	±4°F
Wind Scale	Level 0~12	1	±1
Work Environment	Temperature		0~40°C
	Humidity		≤80%RH
Storage Environment	Temperature		-20~60°C
	Humidity		≤75%RH
Sampling Rate		0.5s	
MAX/AVG		MAX/AVG	
Data Hold		HOLD	
LCD Backlight		Yes	
Battery		AAA 1.5V*3 batteries	



Scan for video

Mini Light Meter w/ Bluetooth

G9400 Series - G9408-Log

The GAZELLE G9408-Log Light Meter is designed to test an extensive range of applications in multiple environments, including the health & safety requirements for streetlights, emergency exits, construction sites, households, and other facilities. The compact pocket-friendly design of the meter makes it easy to carry and use and measures light up to 18,500 FC of lux. It also provides a clear data display of measurements through a backlit LCD screen for the user's convenience.



- Easy to use with auto range and data hold function
- MAX/MIN mode
- Lux/FC selectable

Standard Accessories

- Operating Manual
- 1.5V AAA - 3pcs

Specifications	Range
Illuminance measurement (LUX)	0~199,900Lux
Illuminance measurement (FC)	0~18,500Fc
Accuracy	0~9999Lux/0~999Fc: $\pm(4\%+8)$
	$\geq 10000\text{Lux}/\geq 1000\text{Fc}$: $\pm(5\%+10)$
	$\geq 100000\text{Lux}/\geq 9999\text{Fc}$: $\pm(5\%+10)$
Resolution	1Lux (0~9999Lux)
	10Lux ($\geq 10,000\text{Lux}$)
	100Lux ($\geq 100,000\text{Lux}$)
	1Fc (0~9999Fc); FC=Lux/10.76
	10Fc ($\geq 10,000\text{Fc}$); FC=Lux/10.76
Sampling Time	0.5s
Features	
APP	√
Bluetooth®	√
Overload indication	OL
MAX/MIN	√
Data hold	√
LCD backlight	√
Auto power off	√
Low battery indication	√
Tripod mounting hole	√



Scan for video

Laser Tachometer

G9400 Series - G9409

The G9409 Laser Tachometer is a digital handheld tachometer that takes non-contact measurements of rotation speed. Make safe, non-contact RPM measurements using photoelectric speed sampling processing. Take measurements from 0 to 99,999 RPM of rotating objects by pointing the integral laser from a distance of 50-200mm at the reflective tape placed on the object to be measured.



- Auto range
- Up to 99999 display; overload display, "OL"
- RPM measurement and revolution count
- Max/Min, data hold
- Signal trigger/laser-on indication
- Low battery/auto power off indication
- Big LCD display with bright white backlight for a clear view of measurement

Standard Accessories

- Operating Manual
- Reflective Strips
- 1.5V AAA - 3pcs

Specifications	Range	Resolution	Best Accuracy
RPM measurement	10.0~9999.9 RPM	0.1	±(0.04%+2)
	10000~99999 RPM	1	
Counting measurement	0~99999 count	1 count (<10kHz, pulse width 5%)	±1 count

Features

Target distance	50mm ~ 200mm
Drop test	1m
Working temperature and humidity	0 ° C to 50 ° C (no more than 80%RH)
Storage temperature and humidity	-20 ° C to + 60 ° C (no more than 80%RH)
Power supply	3 1.5V batteries (AAA)
Battery life	Continuous work for 12 hours



Scan for video

Wall Scanner, 80mm

G9400 Series - G9410

The GAZELLE G9410 Wall Scanner, 80mm is used to detect magnetic and non-magnetic metals, electrically charged cables, and wooden substructures with maximum reliability and precision before any drilling applications. The G9410 has a large, illuminated LCD screen to display strength bars indicating the distance of detected material. The wall scanner auto calibration capabilities ensure maximum reliability and accuracy. The ergonomic design of this wall scanner makes it comfortable to hold from any angle.



- Detects metals, live wires, and wood behind walls
- Buzzer, flashing, Silent mode options
- Signal strength bars to indicate the distance of detected material
- Calibration function
- Auto power off when the tools are not in use to save batteries

Standard Accessories

- Operating Manual
- 9V Battery

Specifications	Range
Ferrous metals	80mm
Non-ferrous metals	80mm
Copper conductors (live)	50mm
Wood	20mm
Features	
Buzzer indication	√
LED flashlight	√
Power	1x9V Alkaline Battery



Scan for video

Wall Scanner, 100mm

G9400 Series - G9411

The GAZELLE G9411 Wall Scanner, 100mm is used to detect magnetic and non-magnetic metals, electrically charged cables, and wooden substructures with maximum reliability and precision before any drilling applications. The G9411 has a large, illuminated LCD screen to display strength bars indicating the distance of detected material. The wall scanner auto calibration capabilities ensure maximum reliability and accuracy. The ergonomic design of this wall scanner makes it comfortable to hold from any angle.



- Detects metals, live wires, and wood behind walls
- Buzzer, flashing, Silent mode options
- Signal strength bars to indicate the distance of detected material
- Calibration function
- Auto power off when the tools are not in use to save batteries

Standard Accessories

- Operating Manual
- Battery

Specifications	Range
Detect Principle	Electro-magnetic induction
Detects	Wooden beam, metal object, electric wire
Metal-scan depth	100mm @iron pipe; 80mm @brass pipe
Stud-scan depth (wood)	38mm
AC Electric Wire Depth	50mm
Detect Accuracy	±15mm @28.5mm depth drywall
Notifications	Voice
Power	3.7V 300mAh Li-ion
Product Net Weight	112g
Product Size	135 x 60mm x 25mm

Digital Contact Thermometer

G9400 Series - G9412

The GAZELLE G9412 is an IP65 rated thermometer with FDA certified stainless steel probe. It is equipped with a protective shell to prevent accidental skin puncture and burning. With its portable pen-like design, clear backlight display, and auto power off functions, G9412 is a great temperature measurement tool for cooking, refrigeration, heating, food processing and other industrial applications.



- Backlit LCD screen offers an easy viewing experience in dark conditions
- Max/min/real-time data measurement
- Data hold function allows to lock the temp reading
- Portable pen-like design with easy operation
- LED alarm function for quick notice
- Equipped with food grade SUS304 stainless steel probe which has FDA and GRAS certifications
- IP65 rated water and dust proof allows direct water cleaning available
- Durable with 1m drop proof

Standard Accessories

- Operating Manual
- Battery

Specifications	Range
Measurement Range	-40°C~250°C (-40°F~482°F)
Accuracy	±2°C (-40°C≤T<-20°C)
	±1°C (-20°C≤T≤100°C)
	±2°C (100°C<T≤250°C)
	±4°F (-40°F≤T<-4°F)
	±2°F (-4°F≤T≤212°F)
Minimum measuring depth	12 mm
Sensor	NTC
Stabilization time	20s
Display resolution	0.1°C (0.1°F)
Battery type	1x3V button cell (CR1632)
Battery duration	12 hours
Product size	190x29.5x15.5 mm
Net weight	50.8 g
Operating temperature	0°C~40°C (32°F~104°F)

Specifications	Range
Storage temperature	-20°C~60°C (-4°F~140°F)
Operating humidity	< Rh80% (No condensable)
Protective level	IP65 rated according to IEC60529
Drop test	1m
Certification	CE
Reference standard	JJG226-2001

Temperature and Humidity Logger

G9400 Series - G9413

The GAZELLE G9413 datalogger uses high-precision temperature and humidity sensors to monitor and record data for longer periods. The G9413 is IP67-rated water and dust proof, and can store 60,000 sets of data and transmit them through USB to PC. It is a great solution for monitoring temperature and humidity sensitive goods such as medicine or food during transportation and storage, as well as for greenhouse and energy audit.



- IP67 water and dust resistance
- High accuracy
- Great storage capacity
- USB data transmission
- Image upper computer management and statistics
- High-precision measurement
- Long-time temperature and humidity and atmospheric pressure monitoring and recording

Standard Accessories

- Operating Manual
- Battery

Specifications	Range
IP Rating	IP67
Range	Temperature: -40°C~80°C Humidity: 0%RH~100%RH non-condensation
Resolution	Temperature: 0.1°C Humidity: 0.1%RH
Accuracy	Temperature: -40°C~-30°C: ±2.0°C -30°C~0°C: ±1.0°C -0°C~40°C: ±0.5°C 40°C~70°C: ±1.0°C 70°C~80°C: ±2.0°C Humidity: ±3.0%RH (20%RH~80%RH) ±5.0%RH (<20% or >80%RH)
Data Storage	0~60,000



Scan for video

2-in-1 Laser Distance Meter

G9500 Series - G9501

The GAZELLE G9501 2-in-1 Laser Distance Meter is designed to perform accurate and quick measurements up to 40 m with the laser pointer, and 5 m with the steel tape, saving you time and money. It is distinguished by its simple and intuitive one-button operation. This portable and compact device has basic functionalities including unit measurement conversion, rear measurement reference, and automatic switch-off. The LCD screen displays measurements for the user's convenience. This device can be used in interior/exterior design, construction, traffic, accident evidence gathering, factory supervision, engineering inspection, real estate development and assessment, fire assessment, public facilities planning, gardening, and electronics industries.



- 40 M Laser Distance Measurement Range
- 5 M Steel Tape Measurement Range
- LCD Screen to display measurement
- One-button operation
- Single measurement
- Rear measurement reference
- Unit conversion
- Dual measurement methods
- Portable and compact

Standard Accessories

- Manual
- 1.5V (AAA) Alkaline Batteries
- Cross Screwdriver

Specifications	Range
Display type	LCD
Display size	1.2-inches
Range	40m; tape: 5m
Min. display unit	0.001m
Measurement basis	Rear
Accuracy	±2mm
Laser class	2
Laser type	630~670nm, <1mW
Features	
Single measurement	√
Continuous measurement	√
Auto power off	√
Auto laser off	√
Drop test	1m



Scan for video

Laser Distance Meters

G9500 Series - G9503 & G9504

The GAZELLE G9503 & G9504 Laser Distance Meters are designed to help you measure farther, with greater accuracy, saving time and money. With its easy one-hand operation, take quick measurements of distance, area, and volume, and add & subtract easily. This ergonomic device is manufactured to withstand the inevitable drops and falls on the job site and helps measure hard-to-access areas effortlessly with its easy targeting thanks to the bright laser pointer. Instantly measure up to 100 m distance – just point and click and review the values on the backlit LCD screen. It can also store 99 groups of data. These meters can be used in interior/exterior design, construction, factory supervision, engineering inspection, real estate development and so on.



- Ergonomic exterior, comfortable handling
- Millimeter accuracy
- 99 groups data storage
- Quick, self calculation with real-time readout
- Physical leveler(Horizontal and vertical)
- Multiple functions: Max/Min/continuous measurement, data storage, etc

Standard Accessories

- Operating Manual
- Batteries

Specifications	G9503	G9504
	Range	
Range	50m	100m
Display Size	2 inches	
Display Type	LCD	
Min. Display Unit	0.001m	
Measurement Units	m/ft/in	
Measurement Basis	front/rear	
Accuracy	±2mm	
Laser Class	2	
Laser Type	630~670nm, <1mW	
Single Measurement	√	
Continuous Measurement	√	
Volume	√	
Pythagoras	√	
Add/Subtract	√	
Auto Power Off	3 minutes without operation	
Auto Laser Off	30s without operation	
Storage Temperature	-20°C~60°C	
Operating Temperature	0°C~40°C	
Power	1.5V battery (LR03) x 2	
Product size	122mm x 52mm x 29.5mm	

Laser Leveler

G9500 Series - G9505

The GAZELLE G9505 2-Line Laser Level is a compact, high-speed levelling and alignment solution for fast and accurate level reference in short, mid-range, horizontal and vertical applications. The professional two-line green laser level makes it ideal for both exterior and interior work. With a working range up to 10 meters, the G9505 is an excellent measuring tool for steel stud framing, HVAC installation, electrical works, and residential construction. The device features a rubber-coated housing and a magnetic mounting device that can be attached to any metal plate for maximum versatility. The pendulum lock is designed for safe transport and fast settling, self-levelling tilt mode that provides accurate point and reference lines almost instantly. The easy-to-use one-button operation allows the user to choose between the auto-levelling mode or manual levelling mode, depending on the application.



- Features horizontal and vertical modes which projects two lines for a wide array of level and alignment applications up to 10 meters
- One-button operation to easily choose between the auto-levelling mode or manual levelling mode
- Magnetic mounting device that attaches to metal plates for quick and easy setup
- Smart Pendulum System to self-levels and indicate out-of-level position
- Ergonomic, compact and lightweight – easy to use, easy to store

Standard Accessories

- Operating Manual
- USB Cable
- Adapter

Specifications	Range
Laser Type	Green LD
Laser Lines	2 lines
Operating Distance	10m
Laser Accuracy	±3mm/10m
Self-leveling range	3°±1°
Self-leveling time	3s
Working hours	4h
Laser Wavelength	520nm
Laser Class	2
Power	1.5V battery x 2 (LR6)
Product Net Weight	240g
Product Size	85.5mm x 62mm x 90.3mm

Laser Leveler

G9500 Series - G9506

The GAZELLE G9506 12-Line 3D Laser Level is a compact, high-speed levelling and alignment solution for fast and accurate level reference in short, mid-range, horizontal and vertical applications. The professional twelve-line green laser level makes it ideal for both exterior and interior work with a laser beam up to three times brighter than the red laser beam, making it ideal for projects over longer distances or with lower lighting. With a working range up to 40 meters, the G9506 is an excellent measuring tool for steel stud framing, HVAC installation, electrical works, and residential construction. The device features a rubber-coated housing and a magnetic mounting device that can be attached to any metal plate for maximum versatility. The manual mode allows the user to lock the crossline, so the operator can lock the line and set the level at any desired angle. The pendulum lock is designed for safe transport and fast settling, self-levelling tilt mode that provides accurate point and reference lines almost instantly. The easy-to-use two-button operation allows the user to choose among crossline, horizontal or vertical modes, depending on the application.



- Features horizontal and vertical modes which projects twelve lines for a wide array of level and alignment applications up to 40 meters
- Two-button operation to easily choose between the crossline, horizontal or vertical modes
- Magnetic mounting device that attaches to metal plates for quick and easy setup
- Smart Pendulum System to self-levels and indicate out-of-level position
- Manual mode to lock the line and set the level at any desired angle
- Ergonomic, compact and lightweight – easy to use, easy to store

Standard Accessories

- Operating Manual
- USB Cable
- Adapter

Specifications	Range
Laser Type	Green LD
Laser Lines	3D 12 lines
Operating Distance	40m
Laser Accuracy	±3mm/10m
Outdoor Pulse Mode	√
Remote Control	√
Self-leveling range	±3°
Self-leveling time	<3s
Working Hours	>6h
Laser Wavelength	520nm
Laser Class	2
Power	3.7V Li-ion battery 5200mAh
Product Net Weight	694g
Product Size	138mm x 89mm x 147mm

Laser Leveler

G9500 Series - G9505-II

The GAZELLE G9505-II 2-Line Laser Level is a compact, high-speed levelling and alignment solution for fast and accurate level reference in short, mid-range, horizontal and vertical applications. The professional two-line green laser level makes it ideal for both exterior and interior work. With a working range up to 30 meters, the G9505-II is an excellent measuring tool for steel stud framing, HVAC installation, electrical works, and residential construction. The device features a rubber-coated housing and a magnetic mounting device that can be attached to any metal plate for maximum versatility. The pendulum lock is designed for safe transport and fast settling, self-levelling tilt mode that provides accurate point and reference lines almost instantly. The easy-to-use two-button operation allows the user to choose between the auto-levelling mode or manual levelling mode, depending on the application.



- Laser brightness adjustable 3 levels of saving mode
- Double condenser lens, object modes, horizontal or vertical or cross line laser can be selected
- The vertical line passes through the ceiling, easy for ceiling construction laying process
- Longer operating time 4 x 1.5V x AA batteries
- Pulse mode
- Low power indicator

Standard Accessories

- Instruction manual
- Magnetic mounting bracket
- 4 x AA batteries
- Eye glasses
- Target plate
- Hard carry case

Specifications	Range
Laser type	Green laser
Laser lines	2 lines / vertical / horizontal
Laser class	2
Laser wavelength	505-503nm
H/V accuracy	±2mm/10m
Self-leveling range	4°±1°
Working range	30m
Power supply	1.5V battery x 4
Operating temperature	-10°C to 50°C
Mount size	1/4-20 mounting thread
IP rating	IP54
Storage temperature	-25°C to 75°C
Operating time	~8 hours normal mode ~10 hours pulse mode ~30 hours power saver mode

Laser Leveler

G9500 Series - G9506-II

The GAZELLE G9506-II 12-Line 3D Laser Level is a compact, high-speed levelling and alignment solution for fast and accurate level reference in short, mid-range, horizontal and vertical applications. The professional twelve-line green laser level makes it ideal for both exterior and interior work with a laser beam up to three times brighter than the red laser beam, making it ideal for projects over longer distances or with lower lighting. With a working range up to 40 meters, the G9506-II is an excellent measuring tool for steel stud framing, HVAC installation, electrical works, and residential construction. The device features a rubber-coated housing and a magnetic mounting device that can be attached to any metal plate for maximum versatility. The manual mode allows the user to lock the crossline, so the operator can lock the line and set the level at any desired angle. The pendulum lock is designed for safe transport and fast settling, self-levelling tilt mode that provides accurate point and reference lines almost instantly. The easy-to-use two-button operation allows the user to choose among crossline, horizontal or vertical modes, depending on the application.



- Multifunctional laser tools 3 x 360° 3D green laser
- Power saving outdoor pulse mode
- Self leveling and manual mode, ideal for tilting laser lines manually at any angle
- Type-C charging. 12.5 hours working time on normal mode and 25 hours working time on pulse mode per battery.
- Strong over-molded metal top laser window with IP54 water/dust resistance ensures you work well in hazardous working conditions
- 1/4" and 5/8" mounting threads to suit different tripods

Standard Accessories

- Operating manual
- Magnetic mounting bracket
- USB cable and adapter
- 2 x 7800 mAh battery
- Eye glasses
- Target plate
- Hard carry case

Specifications	Range
Laser type	Green laser
Laser lines	3D 12 lines
Laser class	2
Laser wavelength	520nm
Leveling accuracy	±3mm/10m
Horizontal/Vertical accuracy	±3mm/10m
Leveling duration	≤3s
Leveling/Compensation range	4°±1°
Working distance	30m, 60m pulse mode
Operating time	12.5 hours with all laser beams on 25 hours under pulse mode
Power source	Li-ion battery 7800Mah
IP rating	IP54
Operation temperature range	-10°C~50°C
Storage temperature	-25°C~75°C
Max relative air humidity	90%
Mount size	1/4 and 5/8"
Product net weight	1.05kg
Product size	139mm x 188mm x 99mm



Scan for video

Thermal Imager, 160x120p

G9700 Series - G9701

The GAZELLE G9701 Infrared Thermal Imager delivers industrial performance troubleshooting to boost your team's productivity. With 160 x 120 resolution, the G9701 will enable you to inspect large areas quickly and easily up to 550°C for your HVAC, switchgear, solar & electric panel, electrical, mechanical, and building problems. The camera's manual focus enables you to precisely target areas allowing the camera to maintain sharp images & accurate results. The 3.5inch LCD screen displays infrared images in 4 modes – thermal, fusion, optical, and picture-in-picture to help you find problems faster. Additionally, with 16GB of internal storage, you can document and store thousands of pictures and videos easily. The rechargeable lithium-ion battery can work without a break with for up to 5 hours, giving users peace of mind as they work through challenging tasks. With an ergonomic, rugged build, the G9701 withstands a 2-meter drop test, and with the IP54 rating against dust and water particles, users can work efficiently across several applications. The GAZELLE Mobile and PC software application for thermal imagers allows you to get more from your device with features like remote access to use the camera in real-time to document pictures & videos, tools to optimize images, and create detailed, professional reports.



- 160 x 120 resolution (thermal), and 8 MP resolution (optical)
- DDE, 3D DNR, and adaptive AGC
- 640 x 480 resolution
- 3.5" LCD touch display
- Up to five hours continuous running

Standard Accessories

- User Manual
- Power Adapter Kit
- USB Cable
- Professional Carry Case
- Wrist Strap
- Battery
- Charging Dock

Functions

Thermography

Device detects the real-time temperature and display it on the screen.

Storage

Device is equipped with built-in memory module to store recorded videos, captured snapshots, and important data.

Fusion

Device can display fusion of thermal view and optical view.

Palette and Alarm

Device supports multiple palettes, and you can set the palette mode according to the alarm function.

LED Light

LED Light supplement makes the device a torch in required scenarios.

Laser Light Supplement

Long-distance laser light supplement to point the thermography target.

Specifications		Best Accuracy
Thermal Module	Image Sensor	Uncooled Focal Plane Arrays
	Resolution	25Hz: 160 x 120
	Pixel Pitch	17µm
	Response Waveband	8µm to 14µm
	NETD	< 40 mk (@ 25 °C, F#=1.0)
	Field of View	25° x 18.7°
	Focal Length	6.2 mm (Manual Focus)
	IFOV	2.74 mrad
	Aperture	F 1.1
Optical Module	Picture Resolution	Configurable: 2 MP, 5 MP, 8 MP
	Video Resolution	640 x 480
Image Display	Monitor	640 x 480 resolution, 3.5" LCD touch display
	Palettes	Black hot, White hot, Red hot, Rainbow, Ironbow, Fusion, Rain
	Digital Zoom	Thermal: 1x, 2x, 4x
	Thermal / Optical	Thermal/Optical/Fusion image/Picture in Picture
	Picture in Picture	Support Thermal View in Optical View
	Fusion	Support (Thermal View and Optical View Combined)
	Record Video	Support on-board video recording
Thermography	Rules	Max. Temperature; Min. Temperature; Center Temperature; Custom Point/Line/Area Thermography
	Range	-20 °C to 550 °C (-4 °F to 1022 °F)
	Accuracy	Max (±2 °C, ±2%)
Battery	Battery Type	Dismountable and rechargeable Li-ion Battery
	Battery Operating Time	5 hours in normal temperature, with Wi-Fi, Bluetooth, and supplement light off 4 hours in normal temperature, with Wi-Fi, Bluetooth, and supplement light on
Functions	Laser Light	Support (Point to the thermography target)
	Storage	Built-in memory module (16 G)
	Photo	Thermal/Optical/Fusion Image
	Video	Thermal/Optical/Fusion Image
	Lighting	Support
	Wi-Fi	Support

Image Display Modes

Thermal

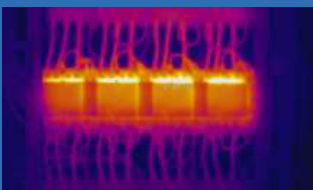

Fusion

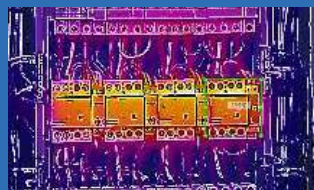

PIP

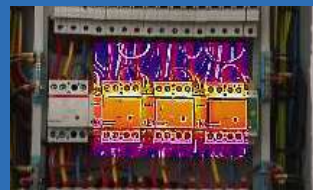

Optical



Accessories

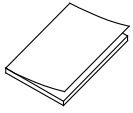

User Manual (x1)



Power Adapter
Kit (x1)

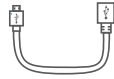

USB Cable (x1)



Professional Carry
Case (x1)



Wrist Strap (x1)



Battery (x2)



Charging
Dock (x1)

Product Applications



HVAC Inspection



Switchgear Inspection



Solar Panel Inspection



Electric Panel Inspection



Industrial Motor Inspection



Building Inspection

Ordering Information

Gazelle G9701 160 x 120 Industrial Thermal Imager; 25 Hz

Included

Thermal Camera; AC Power Supply (including universal adapters);
USB Cable; Hard Carry Case; Wrist Strap; User Manual
Batteries: Charging Dock Station
Available by free download: Gazelle Desktop Software & User Manual



Desktop and Mobile Software Available

- Supports Wi-Fi connection and WLAN hotspot
- Edit and optimize images for simpler analysis
- Generate detailed reports

Li-Ion Battery for G9701

G9701-BAT



- Battery Type: Lithium Battery
- Battery Voltage: 3.7V
- Battery Capacity: 5000 mAh

Battery Charging Dock for G9701

G9701-CHA



- Power Input: 100~240V/0.7A
- Power Output: 12V/2A



Scan for video

Advanced Thermal Imager, 640x512p

G9700 Series - G9706

The GAZELLE G9706 Advanced Thermal Imager is packed with the high-performance features needed for fast and accurate surveying of high-voltage, hazardous targets, to safely and quickly diagnose hotspots that could lead to electrical and mechanical failures. If you are new to thermal imaging or if your camera is being used by a team with varying levels of thermal imaging experience, the G9706 offers a unique combination of 640 x 512 thermal resolution and field of view that allows even a novice thermographer to capture crisp and vibrant images and diagnose critical issues before they lead to system failures. Equipped with both manual and autofocus, you can target areas as close as 6in, or focus on larger areas from a greater distance.

With temperature measurements up to 650°C, it helps quickly and accurately identify temperature problems in most industrial environments. The intuitive touch screen visual interface allows you to easily navigate the device and diagnose issues with sharper onscreen images, thanks to the 800 x 480 screen resolution. The G9706 also comes with an optional interchangeable lens covering the complete coverage of near and distant targets with 0.5x wide angle, as well as 2x and 3x zoom options.



- Thermal resolution: 640 x 512 (327 680 pixels)
- NETD: < 35 mK (@ 25 °C, F#=1.0)
- Temperature measurement range: -20 °C to 650 °C (-4 °F to 1202 °F)
- Accuracy: Max (± 2 °C/3.6 °F, $\pm 2\%$)
- Measurement presets: Center spot, Hot spot, Cold spot, User Preset Point/Line/Area
- Auto/Manual/Laser focus
- 50 Hz image frequency
- 4.3" LCD touch screen display
- 8 MP optical camera
- Up to 4 hours continuous running

Dimensions

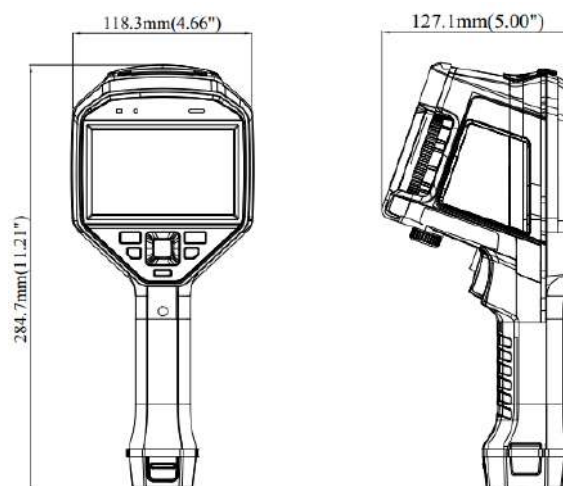

Specifications		Best Accuracy
Thermal Module	Image Sensor	Vanadium Oxide Uncooled Focal Plane Arrays
	IR Resolution	640 x 512 (327 680 pixels)
	Pixel Pitch	17µm
	Spectral Range	8µm to 14µm
	NETD	< 35 mK (@ 25 °C, F#=1.0)
	Focal Length	25 mm
	Field of View	25° × 19°
	Image Frequency	50 Hz
	Focus	Continuous Autofocus/Autofocus/Manual Focus/Laser Assisted Focus
	IFOV (Spatial Resolution)	0.68 mrad
	Aperture	F1.1
	Minimum Focus Distance	0.3 m (0.98 ft)
Optical Module	Picture Resolution	Configurable: 2 MP, 5 MP, 8 MP
	Video Resolution	640 x 480
	Focus	Fixed
	FOV	25° × 19°
Image Display	Display	800 x 480 resolution, 4.3" LCD touch screen
	Color Palettes	Black hot, White hot, Red hot, Rainbow, Ironbow, Fusion, Rain
	Digital Zoom	Thermal: 1x, 2x, 4x, 8x
	Image Modes	Thermal/Optical/Fusion image/Picture in Picture
	Picture in Picture	Thermal Picture in Optical Picture
	Fusion	Thermal Picture and Optical Picture Combined
Measurement and Analysis	Object Temperature Range	-20 °C to 650 °C (-4 °F to 1202 °F)
	Accuracy	Max (±2°C/3.6°F, ±2%)
	Measurement Presets	Center Spot, Hot Spot, Cold Spot, Off
	Point	10 User Presets
	Line	1 User Presets
	Area	3 User Presets
	High Temperature Alarm	Audible Warning
Storage	Color Alarm (Isotherm)	Above/Below/Interval/Insulation
	Storage Media	Removable Micro SD Card (64 GB)
	Image Storage Capacity	60,000 Images
	Image File Format	JPEG with Measurement Data Included
	Video Storage Capacity	54 Hours

Packing List

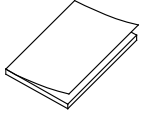

Quick Start Guide (x1)



Type-C Cable (x1)



Hand Strap (x1)



CVBS Cable (x1)

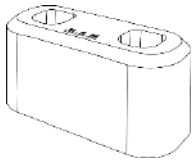

Charging Base (x1)

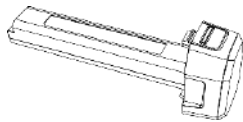

Battery (x2)



Micro SD Card (x1)

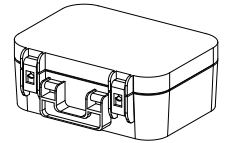

Box (x1)

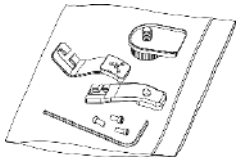

Tools Package (x1)

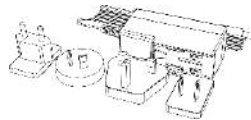

Charger (x1)

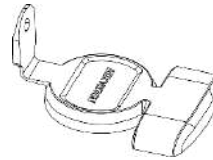

Lens Cover (x1)

Optional



Teleconverter 0.5x



Teleconverter 2x



Teleconverter 3.3x



Desktop and Mobile Software Available

- Supports Wi-Fi connection and WLAN hotspot
- Edit and optimize images for simpler analysis
- Generate detailed reports

Pocket Thermography Camera, 256x192p

G9700 Series - G9710

GAZELLE Pocket Thermography Camera is equipped with a high-resolution VOx detector, an 8 MP optical camera, and a 3.5" LCD touch screen. It helps you quickly and efficiently locate the hidden problems and accurately measure abnormal temperature. The wide temperature range of -20°C to 400°C is ideal for building inspection, HVAC, electrical, and mechanical equipment maintenance. The 25 Hz frame rate keeps up with fast inspections, and the Wi-Fi function allows the Pocket to share images in real time. It is a powerful thermography tool in your pocket, so it is always there whenever you need it.



- Thermal resolution: 256 × 192 (49, 152 pixels), NETD: < 40 mK (@ 25°C, F# = 1.0)
- Accurately measure temperature from -20°C to 400°C (-4°F to 752°F)
- Accuracy: Max. (± 2°C/3.6°F, ± 2%)
- 25 Hz image frequency
- Thermal, fusion, PIP, and optical modes, 8 MP optical camera
- Manual, automatic, and 1-Tap level and span
- High temperature alarm
- Built-in 16 GB memory
- LED work light
- 1.0x to 4.0x continuous digital zoom
- 8 MP Optical camera
- Up to 4 hours continuous running

Dimensions

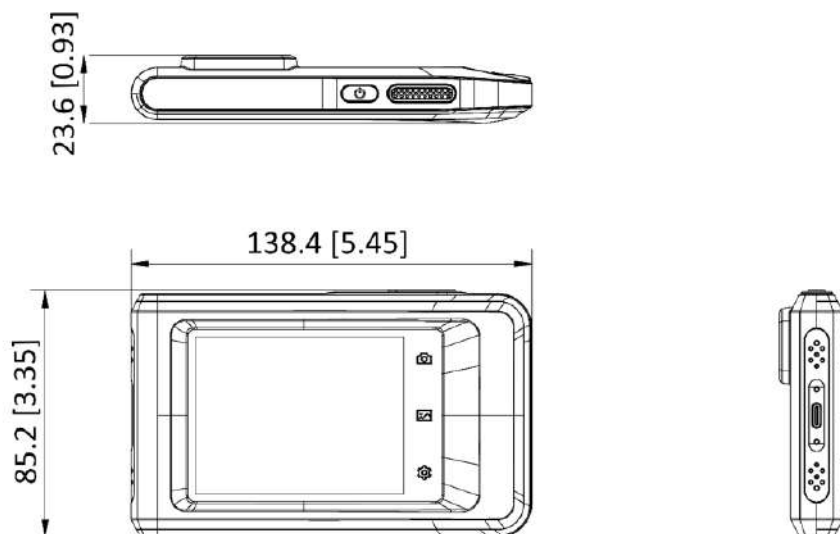

Unit: mm [inch]

Specifications		Best Accuracy
Infrared Image	IR Resolution	256 × 192 (49, 152 pixels)
	NETD	< 40 mK (@ 25°C, F#=1.0)
	Image Frequency	25 Hz
	Detector Pitch	12 μm
	Spectral Range	7.5 to 14 μm
	Focal Length	3.5 mm
	F-number	F1.1
	Field of View (FOV)	50° x 37.2°
	Spatial Resolution (IFOV)	3.43 mrad
	Min. Focus Distance	0.3 m (0.98 ft)
	Focus Mode	Focus Free
Image Display	Visual Camera	3264 × 2448 (8 MP)
	Display	640 × 480 Resolution, 3.5" LCD Touch Screen
	Screen Brightness	Manual
	Digital Zoom	1.0x to 4.0x continuous
	Color Palettes	White Hot, Black Hot, Rainbow, Ironbow, Red Hot, Fusion, Rain
	Image Modes	Thermal/Visual/Fusion/PIP/Blending
Measurement and Analysis	Object Temperature Range	-20°C to 400°C (-4°F to 752°F)
	Accuracy	Max (±2°C/3.6°F, ±2%), for the ambient temp. 15°C to 35°C (59°F to 95°F) and object temp. above 0°C (32°F)
	Measurement Tools	Center Spot, Hot Spot, Cold Spot
	Level and Span Mode	Auto/Manual/1-Tap Touch-screen
Data Storage and Communication	Storage Media	Built-in 16 GB flash memory
	Image Storage Capacity	Approx. 60,000 Images
	Annotations	Voice note: max. 60 seconds; Text note: max. 200 characters
	Video Storage Capacity	Approx. 54 hours
	Video File Format	MP4 video
General	Wi-Fi	802.11 b/g/n (2.4 GHz and 5 GHz)
	Bluetooth	Bluetooth 4.2
	USB Interface	USB Type-C
	LED Light	Yes
	Battery Type	Rechargeable Li-ion battery
	Battery Operating Time	Approx. 4 hours
	Battery Charging Time	Approx. 2.5 hours fully charged
	Protection Level	IP54
	Drop Test Height	2 m (6.56 ft)
	Working Temperature Range	-10°C to 50°C (-4°F to 122°F)
	Storage Temperature Range	-20°C to 60°C (-4°F to 140°F)
	Relative Humidity	< 95% non-condensing
	Weight	Approx. 218 g (0.481 lb)
	Dimension	138.5 × 85.2 × 23.6 mm (5.45 × 3.35 × 0.93 in)
Tripod Mounting	UNC ¼"-20	

Packing List



Camera (x1)



Quick Start Guide (x1)



Power Supply (x1)



USB Cable (x1)

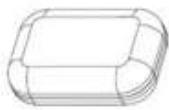

Carrying Pouch (x1)



Wrist Strap (x1)

Optional



P201- MACRO



2925ZJ-TM01-BRACKET
(Accessory Included)



Desktop and Mobile Software Available

- Supports Wi-Fi connection and WLAN hotspot
- Edit and optimize images for simpler analysis
- Generate detailed reports

Heavy Duty Test Lead Probes

G9901

The Gazelle G9901 Heavy Duty Test Lead Probes are designed to enhance your ability to take electrical measurements for a variety of electronics, industrial and automotive applications.



- Leads length: 900mm, Rod length: 136mm
- Tip length: 15.7mm
- Safety level: CAT III 1000V/CAT IV 600V 20A
- Safety certificate: EN 61010-031 A1: 2015
- Features and application: UL 16AWG double insulated wire

Universal Tripod

G9903

The Gazelle G9903 Universal Tripod is made of high-quality aluminum alloy and engineering plastic, which is strong and resistant to falling. It is equipped with a storage bag for easy carrying.



- Adjustable height 600 mm to 1500 mm
- Four-section lever-lock legs provide flexibility
- Universal interface 5/8" screw with 1/4" adapter
- Reinforcement support design

Standard Accessories

- Carrying Bag

Appliance Pass and Failed Labels

G9904



- Easy peel 38x25mm adhesive labels for PAT tested equipment
- Polyvinyl labels for extreme durability
- Each pass label contains space for writing a test date, next due date, fuse rating, appliance ID and the name of the person who carried out the PAT test
- Each fail label contains space for writing a test date, appliance ID and the name of the person who carried out the PAT test pressure monitoring and recording

Items Included

- 1000 pcs. pass stickers roll
- 200 pcs. fail stickers roll

INNOVATION
PERFORMANCE
SAFETY
CONFIDENCE
GAZELLE

GAZELLE®

sales@gazelleindustrial.com | www.gazelleindustrial.com