



Scan for video

## Advanced Thermal Imager, 640x512p

G9700 Series - G9706

The GAZELLE G9706 Advanced Thermal Imager is packed with the high-performance features needed for fast and accurate surveying of high-voltage, hazardous targets, to safely and quickly diagnose hotspots that could lead to electrical and mechanical failures. If you are new to thermal imaging or if your camera is being used by a team with varying levels of thermal imaging experience, the G9706 offers a unique combination of 640 x 512 thermal resolution and field of view that allows even a novice thermographer to capture crisp and vibrant images and diagnose critical issues before they lead to system failures. Equipped with both manual and autofocus, you can target areas as close as 6in, or focus on larger areas from a greater distance.

With temperature measurements up to 650°C, it helps quickly and accurately identify temperature problems in most industrial environments. The intuitive touch screen visual interface allows you to easily navigate the device and diagnose issues with sharper onscreen images, thanks to the 800 x 480 screen resolution. The G9706 also comes with an optional interchangeable lens covering the complete coverage of near and distant targets with 0.5x wide angle, as well as 2x and 3x zoom options.



- Thermal resolution: 640 x 512 (327 680 pixels)
- NETD: < 35 mK (@ 25 °C, F#=1.0)
- Temperature measurement range: -20 °C to 650 °C (-4 °F to 1202 °F)
- Accuracy: Max ( $\pm 2$  °C/3.6 °F,  $\pm 2\%$ )
- Measurement presets: Center spot, Hot spot, Cold spot, User Preset Point/Line/Area
- Auto/Manual/Laser focus
- 50 Hz image frequency
- 4.3" LCD touch screen display
- 8 MP optical camera
- Up to 4 hours continuous running

### Dimensions

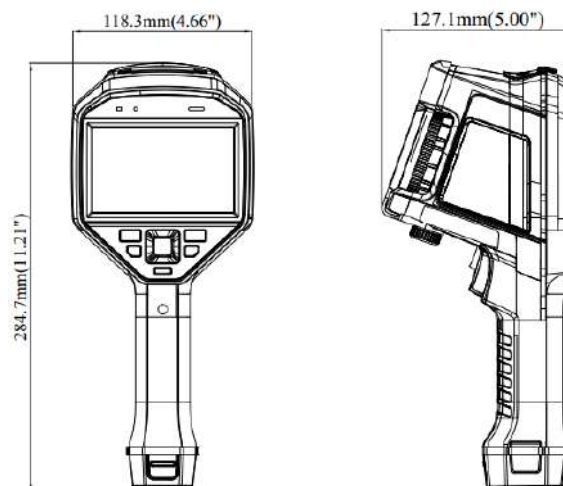

Specifications		Best Accuracy
Thermal Module	Image Sensor	Vanadium Oxide Uncooled Focal Plane Arrays
	IR Resolution	640 x 512 (327 680 pixels)
	Pixel Pitch	17µm
	Spectral Range	8µm to 14µm
	NETD	< 35 mK (@ 25 °C, F#=1.0)
	Focal Length	25 mm
	Field of View	25° × 19°
	Image Frequency	50 Hz
	Focus	Continuous Autofocus/Autofocus/Manual Focus/Laser Assisted Focus
	IFOV (Spatial Resolution)	0.68 mrad
	Aperture	F1.1
	Minimum Focus Distance	0.3 m (0.98 ft)
Optical Module	Picture Resolution	Configurable: 2 MP, 5 MP, 8 MP
	Video Resolution	640 x 480
	Focus	Fixed
	FOV	25° × 19°
Image Display	Display	800 x 480 resolution, 4.3" LCD touch screen
	Color Palettes	Black hot, White hot, Red hot, Rainbow, Ironbow, Fusion, Rain
	Digital Zoom	Thermal: 1x, 2x, 4x, 8x
	Image Modes	Thermal/Optical/Fusion image/Picture in Picture
	Picture in Picture	Thermal Picture in Optical Picture
	Fusion	Thermal Picture and Optical Picture Combined
Measurement and Analysis	Object Temperature Range	-20 °C to 650 °C (-4 °F to 1202 °F)
	Accuracy	Max (±2°C/3.6°F, ±2%)
	Measurement Presets	Center Spot, Hot Spot, Cold Spot, Off
	Point	10 User Presets
	Line	1 User Presets
	Area	3 User Presets
	High Temperature Alarm	Audible Warning
Storage	Color Alarm (Isotherm)	Above/Below/Interval/Insulation
	Storage Media	Removable Micro SD Card (64 GB)
	Image Storage Capacity	60,000 Images
	Image File Format	JPEG with Measurement Data Included
	Video Storage Capacity	54 Hours

## Packing List

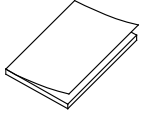

Quick Start Guide (x1)



Type-C Cable (x1)



Hand Strap (x1)



CVBS Cable (x1)

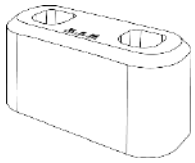

Charging Base (x1)

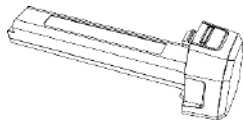

Battery (x2)



Micro SD Card (x1)

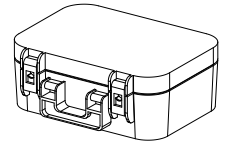

Box (x1)

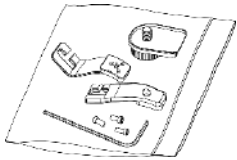

Tools Package (x1)

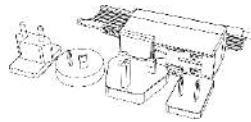

Charger (x1)

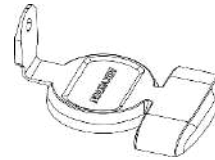

Lens Cover (x1)

## Optional



Teleconverter 0.5x



Teleconverter 2x



Teleconverter 3.3x



### Desktop and Mobile Software Available

- Supports Wi-Fi connection and WLAN hotspot
- Edit and optimize images for simpler analysis
- Generate detailed reports